

UNIVERSITY OF LJUBLJANA
FACULTY OF MATHEMATICS AND PHYSICS
DEPARTMENT OF MATHEMATICS

Drago Bokal

Structural Approach to the Crossing Number of Graphs

Doctoral Thesis

ADVISER: Prof. Dr. Bojan Mohar

Ljubljana, 2006

UNIVERZA V LJUBLJANI
FAKULTETA ZA MATEMATIKO IN FIZIKO
ODDELEK ZA MATEMATIKO

Drago Bokal

**Strukturni pristop k
prekrižnemu številu grafov**

doktorska disertacija

MENTOR: prof. dr. Bojan Mohar

Ljubljana, 2006

Abstract

Crossing-critical graphs were introduced by Širáň, who proved existence of infinite families of 3-connected k -crossing-critical graphs for every $k \geq 3$. Kochol proved existence of infinite families of simple 3-connected k -crossing-critical graphs, $k \geq 2$. Richter and Thomassen started the research on degrees in crossing-critical graphs by proving that there are only finitely many simple k -crossing-critical graphs with minimum degree r for every two integers $r \geq 6$ and $k \geq 1$. Salazar observed that their argument implies the same conclusion for every rational $r > 6$, integer $k \geq 1$, and simple k -crossing-critical graphs with average degree r . For every rational $r \in [4, 6)$ he proved existence of an infinite sequence $\{k_{r,i}\}_{i=0}^{\infty}$ such that for every $i \in \mathbb{N}$ there exists an infinite family of simple 4-connected $k_{r,i}$ -crossing-critical graphs with average degree r and asked about existence of such families for rational $r \in (3, 4)$. The question was partially resolved by Pinontoan and Richter, who answered it positively for $r \in (3\frac{1}{2}, 4)$. In the present work we extend the theory of tiles, developed by Pinontoan and Richter, to encompass a generalization of the crossing-critical graphs constructed by Kochol. Combining tiles with a new graph operation, the zip product, which preserves the crossing number of the involved graphs, we settle the question of Salazar and combine the answer with the results of Širáň and Kochol into the following theorem: there exists a convex continuous function $f : (3, 6) \rightarrow \mathbb{R}^+$, such that, for every rational number $r \in (3, 6)$ and every integer $k \geq f(r)$, there exists an infinite family of simple 3-connected crossing-critical graphs with average degree r and crossing number k .

Beineke and Ringelsen investigated the crossing numbers of Cartesian products of small graphs with cycles and established the crossing numbers of the Cartesian product of $C_n \square G$ where G is any simple graph of order four, except the 3-star, $K_{1,3}$. Jendrol' and Ščerbová closed this gap and also obtained the crossing number of $P_m \square K_{1,3}$. They conjectured the general result for $P_m \square K_{1,n}$, which was proven for $n = 4$ by Klešč. We prove their conjecture in a slightly more general setting: by combining the result of Asano about the crossing number of $K_{1,3,n}$ with the zip product, we establish the crossing number of $T \square K_{1,n}$ where T is any tree of maximum degree three and $n \geq 3$.

is any integer. We supplement this result by the crossing number of $T \square K_{1,3}$ for any tree T , the crossing number of $P_m \square W_n$ for any $m \geq 1$, $n \geq 3$, and some other exact results and bounds.

Seymour regretted that the crossing number does not work well with graph minors, as the contraction of an edge can both increase and decrease the value of this graph invariant. We introduce the minor crossing number, a minor-monotone graph invariant that allows for further minimization of the number of crossings by allowing replacement of vertices by trees and minimizing the number of crossings in the resulting graph. We argue that this graph invariant is more natural in the VLSI applications than the ordinary crossing number, prove several general lower bounds on the minor crossing number, study the structure of graphs with bounded minor crossing number and provide some exact results and bounds for specific graphs. In particular, we generalize a result of Moreno and Salazar, who bounded the crossing number of a graph from below using the crossing number of its minor of small maximum degree.

Math. Subj. Class. (2000): 05C62 Graph representations (geometric and intersection representations, etc.),
05C10 Topological graph theory, imbedding,
05C83 Graph minors.

Keywords: crossing number, crossing-critical graph, average degree, Cartesian product, star, path, tree, wheel, minor crossing number, graph minor.

Povzetek

Raziskovanje prekrizno-kritičnih grafov je začel Širáň, ki je za vsak cel $k \geq 3$ konstruiral neskončno družino 3-povezanih k -prekrizno-kritičnih grafov. Kochol je za vsak cel $k \geq 2$ konstruiral neskončno družino enostavnih 3-povezanih k -prekrizno-kritičnih grafov. Richter in Thomassen sta začela s študijem stopenj vozlišč v prekrizno-kritičnih grafih, ko sta pokazala, da za vsaka cela $r \geq 6$ in $k \geq 1$ obstaja le končno mnogo k -prekrizno-kritičnih grafov z minimalno stopnjo r . Salazar je opazil, da iz njunega argumenta sledi obstoj le končno mnogo k -prekrizno-kritičnih grafov s povprečno stopnjo r za vsak cel $k \geq 1$ in vsak racionalen $r > 6$. Pokazal je, da za vsak racionalen $r \in (4, 6)$ obstaja tako zaporedje $\{k_{r,i}\}_{i=0}^{\infty}$, da za vsak $i \in \mathbb{N}$ obstaja neskončna družina $k_{r,i}$ -prekrizno-kritičnih grafov s povprečno stopnjo r , in vprašal po obstoju takih družin za $r \in (3, 4)$. Na vprašanje sta delno pozitivno odgovorila Pinontoan in Richter, ki sta razvila teorijo tlakovcev in z njeno pomočjo konstruirala iskane družine za $r \in (3\frac{1}{2}, 4)$. V disertaciji nadgradimo njuno delo, da omogoči posplošitev prekrizno-kritičnih grafov, ki jih je konstruiral Kochol. Kombinacija teorije tlakovcev in nove operacije na grafih in njihovih risbah, šiva, nam omogoči popoln odgovor na Salazarjevo vprašanje in njegovo povezavo z rezultati Širáňa in Kochola v obliki naslednjega izreka: obstaja taka zvezna konveksna funkcija $f : (3, 6) \rightarrow \mathbb{R}^+$, da za vsako racionalno število $r \in (3, 6)$ in vsako celo število $k \geq f(r)$ obstaja neskončna družina prekrizno-kritičnih grafov s povprečno stopnjo r in prekriznim številom k .

Beineke in Ringeisen sta raziskovala prekrizno število kartezičnih produktov malih grafov in ciklov ter določila natančne vrednosti za vse $C_n \square G$, kjer je G poljuben graf reda štiri, razen 3-zvezda $K_{1,3}$. Jendrol' in Ščerbová sta zapolnila to vrzel. Ugotovila sta tudi prekrizno število $P_m \square K_{1,3}$ in postavila domnevo za splošen rezultat o $P_m \square K_{1,n}$. Domnevo je za $n = 4$ dokazal Klešč. V nekoliko splošnejši različici jo za vsak $n \geq 3$ dokažemo v pričujočem delu: rezultat Asana o prekriznem številu grafa $K_{1,3,n}$ povežemo z operacijo šiv in dobimo prekrizno število grafa $T \square K_{1,n}$, kjer je T poljubno drevo z maksimalno stopnjo tri in $n \geq 3$ poljubno celo število. Ta rezultat dopolnimo s prekriznim številom grafov $T \square K_{1,3}$ za poljubno drevo T , prekriznim številom

grafov $P_m \square W_n$ za poljubna $m \geq 1$, $n \geq 3$, ter več drugimi eksaktnimi rezultati in mejami.

Seymour je obžaloval, da prekrizno število ne sodeluje na naraven način s teorijo grafovskih minorjev: stiskanje povezave lahko vrednost te invariante poveča ali zmanjša. V tem delu uvedemo minorsko prekrizno število. To je minorsko monotona invarianta, ki omogoča dodatno zmanjševanje števila križišč v risbi, tako da vozlišča zamenjamo z drevesi in minimiziramo število križišč v risbah vseh takih grafov. Ta invarianta ima bolj naravne uporabe pri izdelavi elektronskih vezij kot navadno prekrizno število. V delu pokažemo več splošnih mej za njeno vrednost, raziščemo strukturo grafov z omejenim minorskim prekriznim številom in predstavimo nekaj eksaktnih rezultatov in mej za posamezne družine grafov. Ena od spodnjih mej je posplošitev rezultata Morene in Salazarja, ki sta prekrizno število grafa omejila s prekriznim številom njegovega minorja z majhno maksimalno stopnjo.

Math. Subj. Class. (2000): 05C62 Predstavitve grafov (geometrijske predstavitve, predstavitve s preseki itd.),
05C10 Topološka teorija grafov, vložitve,
05C83 Grafovski minorji.

Ključne besede: prekrizno število, prekrizno-kritičen graf, povprečna stopnja, kar-tezični produkt, zvezda, pot, drevo, kolo, minorsko prekrizno število, grafovski minor.

I implore my memory to reach back, to seize all doubts and despairs, all hopes and passions, all dreams and funerals, all prophecies and disappointments, all the killed, crippled and wounded, desecrated, all exalted on altars and wrapped in flags, all intoxicated by happiness and sobered from sorrow, let me remember all weepings and jublations, all funny stories and loves, all sins, all leaps into the unknown, all fires, floods, earthquakes and God's commandments, let all the tender fragile ties that bind body and soul, me and someone else, be revealed, let me perceive all conceptions and gentle abandons, all the shameful confessions and states of purity, let the remembrances of all these vibrate inside me and my surroundings, and let me be included in the collective guilt and the collective absolution. I, thus, request to be able to keep neighbors in front of and behind me, be the middleman of messages from the future even though they at times are strange, incomprehensible, threatening or calming, brief or tedious. It is probable that none of us fully understands the whole game, but courage itself is absolute and all-knowing.

Edvard Kocbek, 1977

There were many who helped me in my partial understanding of the game. The mother, the father, the sister, the brother, the relatives, the friends, the teachers, the professors, and others. Their trust gave wind to the wings of my thoughts, their doubts challenged me to look deeper and sharpen the arguments.

Some of them are closely related to this work. Bojan Mohar, the supervisor, was with it from the very beginning. He found a balance between encouragement and doubt, strengthened with patience. The weekly meetings of the Graph Theory Workshop he led in Ljubljana were of high value to an apprentice. Gašper Fijavž introduced me to crossing number problems at a conference in Košice. In Stará Lesná, Marián Klešč pointed out a problem that later turned out to be easily accessible with the developed tools. Bruce Richter and Gelasio Salazar not only developed the fundament on which this work was built, but also expressed interest in it at a stimulating meeting in Waterloo, just prior the text was written up. Matt DeVos, always willing for a mathematical debate, had several terminological suggestions. Deborah Kent took time to improve on the English. Andrej Vodopivec, together with Deborah, Matt, and the Mohar family, made the stay in Burnaby, where the work has been completed, an enjoyable experience. Franziska Berger was the inspiration to many of the thoughts in the thesis.

To all, my sincerest thanks.

Prosim, da bi mi spomin segel daleč nazaj in obsegel vse dvome in obupe, vsa upanja in zanose, vse sanje in pogrebe, vse prerokbe in razočaranja, vse ubite, pohabljene in ranjene, oskrunjene, vse na oltar povzdignjene in v zastave ovite, blazne od sreče in trezne od nesreče, naj se spomnim vseh jokov in vriskov, vseh smešnic in ljubezni, vseh grehov, vseh skokov v neznano, vseh požarov, povodnji, potresov in božjih zapovedi, naj si odkrijem vse nežne nitke, ki vežejo telo in dušo, mene in bližnjika, naj si predočim vsa spočetja in blage sprostitive, vsa sramotna priznanja in vsa čista stanja, vsega tega naj se spomnim v sebi in v svoji okolici, predvsem pa naj se vključim v skupno krivdo in v skupno odvezo. Prosim torej, da bi se še dalje držal soseda pred seboj in soseda za seboj in sprejemal poročila od spredaj in jih predajal nazaj, čeprav so včasih tuja, nerazumljiva, preteča ali pomirljiva, kratka in naporna. Morda nihče med nami ne razume igre do kraja, vendar je drznost brezpogojna in vsevedna.

Edvard Kocbek, 1977

Mnogo jih je bilo, ki so mi pomagali pri iskanju razumevanja igre. Mati, oče, sestra, brat, sorodniki, prijatelji, učitelji, profesorji in drugi. Njihovo zaupanje je dalo pol leta mojim zamislim, njihovi dvomi so izzvali globlji pogled in izostritev argumentov.

Nekateri od njih so tesno povezani s tem delom. Bojan Mohar, mentor, je bil z njim od vsega začetka. Našel je ravnovesje med spodbudo in dvomom, utrjeno s potrpežljivostjo. Tedenska srečanja Grafovske delavnice, ki jo je vodil v Ljubljani, so bila dober poduk za vajenca. Gašper Fijavž mi je na konferenci v Košicah predstavil prekrizno število grafov. V Starí Lesní je Marián Klešč izpostavil problem, ki se je kasneje izkazal za lahko dostopnega z izdelanimi orodji. Bruce Richter in Gelasio Salazar sta ne le zgradila temelje, na katerih sloni to delo, ampak tudi izkazala zanimanje zanj na spodbudnem srečanju v Waterlooju tik pred pisanjem besedila. Matt DeVos, vedno pripravljen na matematični razgovor, je imel več terminoloških predlogov. Deborah Kent si je vzela čas za izboljšavo uporabljene angleščine. Andrej Vodopivec je skupaj z Deborah, Mattom in družino Moharjevih poskrbel, da je bil čas v Burnabyu, kjer je bilo delo dokončano, prijetna izkušnja. Franziska Berger je bila navdih mnogim mislim v disertaciji.

Vsem iskrena hvala.

Contents

Abstract	vii
Povzetek	ix
I The Crossing Number	1
Introduction	3
1 Graphs and their drawings	5
1.1 Graphs	5
1.1.1 Basic definitions	5
1.1.2 Families of graphs	7
1.1.3 Graph minors	8
1.2 Drawings	9
1.2.1 Embeddings of graphs on surfaces	9
1.2.2 Drawings of graphs and the crossing number	10
2 Results on the crossing number	13
2.1 Historic overview	13
2.2 General bounds	15
2.3 Exact results	18
2.4 Crossing-critical graphs	21
2.5 Applications	23
2.6 Contribution of this thesis	25
II Crossing-critical Graphs	29
3 Zip product	31
3.1 Definition and basic lemmas	31
3.2 Homogeneity condition	35

4	Tiles	39
4.1	Definition and basic lemmas	39
4.2	Properties of tiles	41
4.3	Gadgets in tiles	43
4.3.1	Twisted pairs	44
4.3.2	Staircase strips	45
4.3.3	Cloned vertices	50
4.3.4	Wheel gadgets	51
4.3.5	Other gadgets	52
5	Constructions	55
5.1	Average degree three	55
5.2	Average degree six	57
5.3	Adapting graphs	59
5.4	Infinite families	60
5.5	Structure of crossing-critical graphs	62
6	Cartesian products	65
6.1	General graphs	65
6.2	Cycles	67
6.3	Stars	68
6.4	Wheels	69
III	The Minor Crossing Number	73
7	Preliminaries	75
7.1	Definitions and basic lemmas	76
7.2	Cubic realizing graphs	77
8	Bounds	79
8.1	Using the maximum degree	79
8.2	Using the genus	81
8.3	Using the connected components	83
9	Structure of graphs with bounded $\text{mcr}(G, \Sigma)$	85
9.1	Systems of curves	86
9.2	Structure theorem	87
9.3	Improved bound	89

10 Applications	91
10.1 Complete graphs	91
10.2 Complete bipartite graphs	93
10.3 Hypercubes	94
10.4 Cartesian products of cycles	96
Bibliography	97
Index of terms	109
Index of symbols	115
Razširjeni povzetek	117
Definicije	117
Prispevek disertacije k teoriji prekriznega števila	118
Prekrižno-kritični grafi	121
Kartezični produkti	133
Minorsko prekrižno število	135

Part I

The Crossing Number

Introduction

In his 1917 book, *Amusements in Mathematics*, Henry Ernest Dudeney published the following problem [28]:

There are some half-dozen puzzles, as old as the hills, that are perpetually cropping up, and there is hardly a month in the year that does not bring inquiries as to their solution. Occasionally one of these, that one had thought was an extinct volcano, bursts into eruption in a surprising manner. I have received an extraordinary number of letters respecting the ancient puzzle that I have called “Water, Gas, and Electricity.” It is much older than electric lighting, or even gas, but the new dress brings it up to date. The puzzle is to lay on water, gas, and electricity, from W, G, and E, to each of the three houses, A, B, and C, without any pipe crossing another. Take your pencil and draw lines showing how this should be done. You will soon find yourself landed in difficulties.

A contemporary graph-theoretical view of the problem provides a simple proof that the puzzle has no solution: it is asking for a planar embedding of the complete bipartite graph $K_{3,3}$, which does not exist due to the Euler Formula. This puzzle is to our knowledge the first appearance of the problem of minimizing the number of crossings in a drawing. Although the origins of this problem can be traced back to recreational mathematics, it turns to be quite difficult and has attracted considerable attention of modern mathematicians, including Turán, Erdős, and Tutte. The bounds on the minimum number of crossings in a drawing of a graph on a surface, called the crossing number, have been applied in several areas of mathematics.

In this thesis we study two structural approaches to the crossing number invariant. After the introductory Part I we investigate crossing-critical graphs in Part II and the minor crossing number in Part III.

In the first part we introduce the terminology and notation in Chapter 1 and review the results on the crossing number in Chapter 2.

The second part contains solutions to two previously open problems. In it, we study the crossing-critical graphs, which are minimal graphs with the

crossing number above some predefined bound and thus give insights into the structural behavior of this graph invariant. In Chapter 3 we define a new graph operation, the zip product, which can preserve the crossing number and the criticality of the involved graphs. Chapter 4 builds upon the theory of tiles of Pinontoan and Richter, which we augment with a general construction of crossing-critical graphs and with some new gadgets that are used to establish lower bounds on the crossing numbers of graphs. The tools designed in these two chapters are applied in Chapter 5, where we settle a question of Salazar, and discuss the new insights these tools provide into the structure of crossing-critical graphs. The zip product also has applications in studies of the crossing numbers of Cartesian products of graphs, which we present in Chapter 6. There we settle a conjecture of Jendrol' and Ščerbová.

Connections between the theory of graph minors and the crossing number are studied in the third part of this thesis. In Chapter 7 we introduce a new minor-monotone graph invariant, the minor crossing number, and establish some of its basic properties. This invariant allows us to apply the techniques of graph minors in the study of the crossing minimization problem. In Chapter 8 we present some general bounds for the minor crossing number and in Chapter 9 we discuss the structure of graphs with bounded value of this graph invariant and apply the results to improve the previously obtained bounds. We conclude the study of the minor crossing number by establishing some exact results and bounds for several classical families of graphs in Chapter 10.

Chapter 1

Graphs and their drawings

In this chapter, we define the mathematical framework and the notation that will be used in subsequent chapters. We assume familiarity with basics of Graph Theory [27] and related Topology of Surfaces [85]. Also, some arguments have an algebraic flavor [52]. The respective references provide sufficient background for these topics.

1.1 Graphs

1.1.1 Basic definitions

A *graph* G is a structure consisting of two sets: $V(G)$ are the *vertices* of G and $E(G)$ are the *edges* of G . Each edge e connects precisely two *endvertices* u and v , which is denoted by $e = uv$. The endvertices need not be distinct, and an edge whose endvertices are equal is called a *loop*. An edge is *incident* with its endvertex and vice versa. Two endvertices of the same edge are *adjacent*, as well as two edges sharing an endvertex. Adjacent vertices are *neighbors* of each other. For a vertex $v \in V(G)$ we denote with $N_G(v) = \{u \in V(G) \mid uv \in E(G)\}$ its *neighborhood* in G . We also define the *multiplicity neighborhood* $N_G^*(v)$, which is the multiset that contains each neighbor u of v with multiplicity of the edge uv in $E(G)$. Then the *degree* of v in G equals the size of $N_G^*(v)$, $\deg_G(v) = |N_G^*(v)|$. The *maximum* and *minimum degree* of a graph G are denoted by $\Delta(G)$ and $\delta(G)$, respectively. A graph is *d-regular* if all its vertices have degree d . Graphs with maximum degree three are called *subcubic graphs* and 3-regular graphs are called *cubic graphs*. A graph can have multiple edges but not loops, for reasons discussed in Section 1.2.2. When loops are present, we employ the term *multigraph*. A graph that has neither loops nor multiple edges is a *simple graph*.

We call a vertex $v \in V(G)$ a *dominating vertex* of G if it is adjacent to every other vertex in G . A *vertex cover* of G is a set S of vertices of G , such that each edge of G is incident with some vertex in S .

Let G_1 and G_2 be two graphs and $\varphi : V(G_1) \rightarrow V(G_2)$ a function. If $uv \in E(G_1)$ is equivalent to $\varphi(u)\varphi(v) \in E(G_2)$, we say that φ is a *homomorphism* of G_1 into G_2 . If φ is also a bijection, then it is an *isomorphism* and G_1 and G_2 are *isomorphic graphs*. Throughout this thesis we do not distinguish between isomorphic graphs.

A graph G is a *subgraph* of a graph H whenever $V(G) \subseteq V(H)$ and $E(G) \subseteq E(H)$. We denote such a relationship with $G \leq H$. If $U \subseteq V(G)$, then $G[U]$ is the subgraph of G that contains the vertices U and precisely all the edges of G with both endvertices in U . Similarly, for $F \subseteq E(G)$, the graph $G[F]$ is the graph that contains all the edges of F and precisely those vertices of G that are endvertices of edges in F . We say that $G[U]$ and $G[F]$ are *spanned* by U and F , respectively. A subgraph $G \leq H$ is a *spanning subgraph* if $V(G) = V(H)$. It is *induced* if $H[V(G)] = G$, i.e. if it contains all the edges of H that have both endvertices in H . If there exists a subgraph of G , isomorphic to H , we refer to it as a subgraph H in G . For a graph G , an edge $e \in E(G)$, and a vertex $v \in V(G)$ we define $G - e = (V(G), E(G) \setminus \{e\})$ and $G - v = G[V(G) \setminus \{v\}]$ to be the subgraphs obtained by removing e or v from G . Similarly we define $G - S$ for $S \subseteq V(G) \cup E(G)$.

The *path* of length m , P_m , is the graph consisting of a sequence of vertices v_0, v_1, \dots, v_m such that precisely every two consecutive vertices v_{i-1} and v_i are adjacent, $i = 1, \dots, m$. Similarly, the *cycle* C_m is the graph consisting of a sequence of vertices v_0, v_1, \dots, v_{m-1} such that precisely every two vertices v_{i-1} and v_i are adjacent, $i = 0, \dots, m-1$, where the subtraction is modulo m . We denote the segment of P between $u, v \in V(P)$ with uPv , and we use a shorthand Pu for v_0Pu and uP for uPv_m . The *length* of a cycle or a path is the number of its edges. Note that both P_m and C_m have m edges, but P_m has $m+1$ vertices, one more than C_m . *Girth* $r(G)$ of a graph G is the length of the shortest cycle in G . A graph G is a *forest* if it contains no cycles. If, in addition, it is connected, then it is a *tree*.

Two vertices $u, v \in V(G)$ are *connected* in G if there exists a path uPv in G . This is an equivalence relation. The subgraphs of G spanned by its equivalence classes are called *components* of G . A set $S \subseteq V(G) \cap E(G)$ is a *separator* in G if $G - S$ has more components than G . We say that G is *connected*, or *1-connected*, if G has only one component. G is *k-connected* if $|V(G)| \geq k+1$ and $G - S$ is connected for any set $S \subseteq V(G)$, $|S| < k$. Similarly, we define *k-edge-connected* for $S \subseteq E(G)$. A vertex $v \in V(G)$ or an edge $e \in E(G)$ is a *cutvertex* (*cutedge*) if $\{v\}$ ($\{e\}$) is a separator in G .

Two edges $e, f \in E(G)$ are in the same *block* of G if they are equal or

if there exists a cycle C in G with $e, f \in E(C)$. This is another equivalence relation; the subgraphs spanned by the equivalence classes are called blocks of G . For a graph G we define its *block graph* H as follows: the set of vertices $V(H)$ contains all the cutvertices and blocks of G , and the set of edges of H contains precisely all the edges of the form vB where v is a cutvertex, B a block, and $v \in V(B)$.

Proposition 1.1 ([27]). *The block graph H of any graph G is a forest. H is connected if and only if G is connected.*

Let G_1, G_2 be two subgraphs of G . The *intersection* $G_1 \cap G_2$ is the subgraph of G , having the vertices $V(G_1) \cap V(G_2)$ and the edges $E(G_1) \cap E(G_2)$. Let G_1, G_2 be two disjoint graphs. Their *disjoint union* $G_1 \cup G_2$ has vertices $V(G_1) \cup V(G_2)$ and edges $E(G_1) \cup E(G_2)$. Their *join* $G_1 + G_2$ is obtained from $G_1 \cup G_2$ by adding all the edges of $\{uv \mid u \in V(G_1), v \in V(G_2)\}$. Their *Cartesian product* $G_1 \square G_2$ has vertices $V(G_1) \times V(G_2)$; two vertices (u_1, v_1) and (u_2, v_2) are adjacent if and only if $u_1u_2 \in E(G_1)$ or $v_1v_2 \in E(G_2)$. *Complement* G^c of a (simple) graph G is the simple graph on vertices $V(G)$ in which two vertices are adjacent if and only if they are not adjacent in G . *Line graph* $L(G)$ of G is the graph whose vertices are $E(G)$ and two of them are adjacent if and only if they share a vertex in G .

Let $e = uv$ be an edge of a graph G . A *subdivision* of e results in the graph obtained from G by replacing e in G with a new vertex w adjacent precisely to u and v . A graph H is a *subdivision* of G if it is obtained from G by a sequence of subdivisions of edges. In such case, we also say that G and H are *homeomorphic* graphs.

Let $u \in V(G)$ be a vertex of degree three with neighbors x, y, z . The *$Y\Delta$ -transformation* of G at u is the graph obtained from $G - u$ after adding the edges xy, yz , and zx . Conversely, if xy, yz , and zx are three edges (a *triangle*) in G , then the *ΔY -transformation* of G at the triangle xyz is the graph obtained from $G - \{xy, yz, zx\}$ by adding a new vertex u and the edges xu, yu , and zu .

A *k -coloring* of vertices of G is a mapping $c : V(G) \rightarrow \{1, \dots, k\}$ that assigns different colors to adjacent vertices. A *k -edge-coloring* is defined similarly. The *chromatic number* $\chi(G)$ of a graph G is the smallest number k for which a k -vertex coloring of G exists. The *chromatic index* $\chi'(G)$ of G is the smallest k for which a k -edge-coloring of G exists.

1.1.2 Families of graphs

In this section we define several particular families of graphs used throughout the thesis. The *complete graph* K_n is the graph with vertices $V(K_n) =$

$\{v_1, \dots, v_n\}$ and edges $E(K_n) = \{v_i v_j \mid 1 \leq i < j \leq n\}$, i.e. it contains an edge between any pair of distinct vertices. The *empty graph* \bar{K}_n is the complement of K_n : it has n vertices $V(\bar{K}_n) = \{v_1, \dots, v_n\}$ but no edges. The *complete bipartite graph* $K_{m,n}$ has vertices partitioned into two sets $A = \{u_1, \dots, u_m\}$, $B = \{v_1, \dots, v_n\}$, $V(K_{m,n}) = A \cup B$, and has all possible edges between vertices of these sets: $E(K_{m,n}) = \{u_i v_j \mid 1 \leq i \leq m, 1 \leq j \leq n\}$. The *n -star* S_n is the complete bipartite graph $K_{1,n}$. We have already defined the path P_m and the cycle C_m . The *wheel* W_n is the join of the cycle C_m with the graph K_1 . The *hypercube* of dimension d is the graph Q_d whose vertices are strings of length d over the alphabet $\{0, 1\}$. Two such strings are adjacent in Q_d if and only if they differ in precisely one position. An alternative definition is $Q_d = K_2 \square K_2 \square \dots \square K_2$ with precisely d factors K_2 .

1.1.3 Graph minors

Let $e = uv$ be an edge of a graph G that is not a loop. The *contraction* of e results in the graph G/e in which the edge e is removed and the vertices u and v are identified into a new vertex. In the context of graph minors, we forbid removal of cutedges of G . Thus, cut-edges can only be contracted and loops can only be removed.

A graph G is a *minor* of a graph H if G can be obtained from a subgraph of H by a sequence of edge-contractions. We denote this relationship by $G \leq_m H$. Then the set of edges of H can be partitioned into the set $E(G)$ of *original edges*, C of *contracted edges*, and the set $R = E(H) \setminus (E(G) \cup C)$ of *removed edges*. $H[C]$ is a forest since the loops are removed and not contracted. To each vertex $v \in V(G)$, there corresponds a unique maximal tree T_v , a component of $H[C]$, which is contracted to v .

A *property* \mathcal{P} is a subclass of the class of all graphs. It is *minor-closed* if, for every $H \in \mathcal{P}$, the property \mathcal{P} contains every minor G of H . A graph invariant ι , which assigns real numbers to graphs, is *minor-monotone* if $G \leq_m H$ implies $\iota(G) \leq \iota(H)$. The property $\mathcal{P}_k = \{G \mid \iota(G) \leq k\}$ is minor-closed whenever ι is a minor-monotone graph invariant. The following theorem provides a structural characterization of graphs in minor-closed properties.

Theorem 1.2 ([27]). *Let \mathcal{P} be a minor-closed property. Then there exists a finite set of graphs $\mathcal{F}_{\mathcal{P}}$, such that $G \in \mathcal{P}$ if and only if G does not contain a minor that is isomorphic to a graph in $\mathcal{F}_{\mathcal{P}}$.*

The family $\mathcal{F}_{\mathcal{P}}$ from this theorem is the set of *forbidden minors* of \mathcal{P} .

1.2 Drawings

1.2.1 Embeddings of graphs on surfaces

A *surface* Σ is a compact connected 2-manifold without a boundary, i.e. a compact connected Hausdorff space in which every point has a neighborhood homeomorphic to \mathbb{R}^2 . Surfaces can be classified into *orientable surfaces* \mathbb{S}_h , $h \geq 0$, and *nonorientable surfaces* \mathbb{N}_c , $c \geq 1$, where \mathbb{S}_h denotes the 2-sphere with h handles and \mathbb{N}_c denotes the 2-sphere with c crosscaps. The number h is the *orientable genus* of \mathbb{S}_h and c is the *nonorientable genus* of \mathbb{N}_c . Some particular surfaces we consider are the *torus* \mathbb{S}_1 , the *projective plane* \mathbb{N}_1 , and the *Klein bottle* \mathbb{N}_2 .

An *embedding* of a graph G in a surface Σ consists of two mappings (φ, ε) , such that $\varphi : V(G) \rightarrow \Sigma$ maps vertices of G injectively into points in Σ and $\varepsilon : E(G) \times [0, 1] \rightarrow \Sigma$ maps edges of G into simple (polygonal) paths in Σ , such that (i) for $e = uv$ the corresponding path connects the images of the respective endvertices, i.e. $\varepsilon(e, 0) = \varphi(u)$ and $\varepsilon(e, 1) = \varphi(v)$, (ii) the interiors of any two paths are disjoint, i.e. $\varepsilon(e, (0, 1)) \cap \varepsilon(f, (0, 1)) = \emptyset$ for any $e, f \in E(G)$, $e \neq f$, and (iii) the interiors of paths avoid the images of vertices, i.e. $\varepsilon(e, (0, 1)) \cap \varphi(V(G)) = \emptyset$ for $e \in E(G)$.

Let G be a graph and (φ, ε) its embedding in a surface Σ . The (open) connected components of $\Sigma \setminus \varepsilon(E(G) \times [0, 1])$ are the *faces* of the embedding. If a vertex or an edge is embedded in the boundary ∂f of the face f , then v or e is *incident* with f . Two faces whose boundaries intersect in the image of an edge are *adjacent*. The boundary of a face f determines a sequence of vertices and edges incident with f , which is called a *facial walk* of f . For a vertex $v \in V(G)$, the embedding determines a cyclic permutation of edges emanating from v , which corresponds to a cyclic permutation of the neighbors of v . This permutation is called the *vertex (edge) rotation* around v .

For every surface Σ , there exists a constant $\chi(\Sigma)$, called the *Euler characteristic* of Σ , such that if G is a graph with n vertices and m edges whose embedding in Σ has f faces, all homeomorphic to disks, then

$$n - m + f = \chi(\Sigma). \quad (1.1)$$

The equation (1.1) is called the *Euler Formula*. The constant depends only on the (non)orientable genus of Σ : $\chi(\mathbb{S}_g) = 2 - 2g$ and $\chi(\mathbb{N}_g) = 2 - g$. To unify these formulas, we define the *Euler genus* of a surface to be $\text{eg}(\mathbb{S}_g) = 2g$ and $\text{eg}(\mathbb{N}_g) = g$; then $\chi(\Sigma) = 2 - \text{eg}(\Sigma)$.

For a graph G , we define its *orientable genus* $g(G)$ as the smallest g , such that there exists an embedding of G into \mathbb{S}_g . The *nonorientable genus* $\tilde{g}(G)$ is

defined similarly with \mathbb{N}_g in place of \mathbb{S}_g . The *Euler genus* $\text{eg}(G)$ is defined as $\text{eg}(G) = \min\{2g(G), \tilde{g}(G)\}$.

1.2.2 Drawings of graphs and the crossing number

A *drawing* $D = (\varphi, \varepsilon)$ of G in a surface Σ is a generalization of an embedding in Σ , in which the interiors of the ε -images of edges are allowed to intersect. Again, $\varphi : V(G) \rightarrow \Sigma$ is an injective mapping and $\varepsilon : E(G) \times [0, 1] \rightarrow \Sigma$ maps edges of G to simple (polygonal) curves in Σ , such that $\varepsilon(uv, 0) = \varphi(u)$ and $\varepsilon(uv, 1) = \varphi(v)$, and $\varphi(V(G))$ does not intersect $\varepsilon(E(G) \times (0, 1))$. When the context is clear we do not distinguish between a graph, its vertices or edges, and their images in a surface.

Let e and f be distinct edges of G and let r and s be their images in Σ . Suppose that $x \in r \cap s$ is not an image of some vertex of G . Let U be a neighborhood of x such that for each disk neighborhood $B \subseteq U$ of x both $B \cap r \cap s = \{x\}$ and $|\partial B \cap (r \cup s)| = 4$. We say that e and f or that r and s *cross* at x (and call x a *crossing*) if points of r and s interlace along ∂B for every such B , and say that r and s *touch* otherwise. In the latter case, we call x a *touching* of r and s (of e and f).

A drawing D is *normal* if the ε -images of any two edges intersect in a finite number of points, D has no touchings, and for each crossing x of D there are at most two edges of G whose crossing is x . We will assume that all the drawings are normal. Let $D = (\varphi, \varepsilon)$ be one such drawing of a graph G and let X be the set of crossings of D . The *graph of the drawing* D , G_D , has vertices $V(G_D) = V(G) \cup X$. Two of its vertices $u, v \in V(G_D)$ are adjacent if there is an edge $e \in E(G)$ whose ε -image contains u and v , but the $u - v$ segment of that image contains no other vertex of G_D .

The *crossing number* of a graph G in Σ , denoted by $\text{cr}(G, \Sigma)$, is defined as the minimum number of crossings in any normal drawing of G in Σ . The symbol $\text{cr}(G)$ denotes the crossing number of G in the sphere. A drawing of G in Σ that achieves the minimum number of crossings is called an *optimum drawing*. For a drawing $D = (\varphi, \varepsilon)$ of G in Σ , connected regions of $\Sigma \setminus \varepsilon(E(G))$ are called *faces* of D . By our standards, a drawing of G in the plane \mathbb{R}^2 is a drawing of G in the sphere \mathbb{S}_0 , equipped with an *infinite point* ∞ avoiding the image of G . The *infinite face* of a drawing of G in the plane is the face containing ∞ .

A graph G is *k-crossing-critical* in a surface Σ if $\text{cr}(G, \Sigma) \geq k$ and $\text{cr}(G - e, \Sigma) < k$ for any edge $e \in E(G)$. A graph is *crossing-critical* in Σ if it is *k-crossing-critical* for some k .

A *rectilinear drawing* is a drawing of a simple graph G in the plane, \mathbb{R}^2 , in which the image of any edge is a straight line segment. The *rectilinear crossing*

number $\text{rcr}(G)$ is the smallest number of crossings in any rectilinear drawing of G in the plane.

Loops do not affect the crossing number of graphs: we can always draw them in a small neighborhood of the vertex without any crossings. Thus, a graph with a given crossing number can have arbitrarily many loops, and a crossing-critical graph contains none.

Chapter 2

Results on the crossing number

In this chapter, we review significant results on the crossing number. First, we outline the historic development of the topics in Section 2.1. Then, we concentrate on general crossing number bounds in Section 2.2 and on exact results in Section 2.3. Next, we continue with an overview of results on crossing-critical graphs in Section 2.4 and applications of the crossing number invariant in mathematics and engineering in Section 2.5. Finally, we conclude with the contribution of this thesis to the knowledge about crossing numbers in Section 2.6.

2.1 Historic overview

In 1930, Kuratowsky characterized planar graphs as the graphs that contain neither a $K_{3,3}$ nor a K_5 subdivision [74]. This result was followed in 1934 by Chojnacki, who established planarity of any graph that has a plane drawing in which no pair of edges crosses an odd number of times [24]. In the present terminology, this result states that any graph with odd crossing number equal to zero is planar. Many years later, Tutte proved this result in his attempt to create algebraic foundations for the theory of crossing numbers [131]. The module over the set of pairs of edges that he created made the proof clearer, but was applied only in few other results [124].

Turán asked about the smallest number of crossings of rail tracks between kilns and storage places [130]. In graph theoretical formulation, he was interested in the crossing number of the complete bipartite graph $K_{m,n}$. This initial question already demonstrated all the fallaciousness of the crossing number problems: in 1952 Turán presented the problem to Zarankiewicz, who claimed to have solved it in 1954 [137]. However, a fault in the proof was discovered by Kainen and Ringel and described by Guy [47], who also conjectured the cross-

ing number of complete graph K_n . Until today, both problems were solved only in some special cases (cf. Section 2.3).

After the 1950s, the research on crossing numbers continued in various directions. Some of it was dedicated to finding or estimating crossing numbers of graphs, cf. Sections 2.2 and 2.3. There were also attempts to characterize properties of graphs with given crossing number. The result of Kuratowsky characterizes graphs with crossing number zero in terms of forbidden subdivisions, but for larger crossing numbers no such general results are known. Kulli, Akka and Beineke characterized line graphs with crossing number one [73]. Bloom, Kennedy and Quintas conjectured that a graph with crossing number at least two contains a subgraph with crossing number equal to two [17]. Several special cases of this conjecture were proven by Richter [99], who also established that every cubic graph with crossing number at least two contains a subdivision of one of eight graphs [98], which extends a similar result of Glover and Huneke [43] for cubic graphs that do not embed in the projective plane. A complementary result of McQuillan and Richter states that every cubic 2-crossing-critical graph has crossing number equal to two [81]. This relates to crossing-critical graphs, which were first defined in [17]. As they are one of the main topics of this thesis, we devote them more space in Section 2.4.

Garey and Johnson opened the algorithmic aspect of the crossing number by showing that the question $\text{cr}(G) \leq k$ is NP-complete [40]. Their transformation to the optimal linear arrangement problem uses multigraphs with high multiplicity of edges and high vertex degree. Recently, Hliněný improved upon their transformation to the optimal linear arrangement problem by using simple cubic graphs [55]. The result is that the crossing number problem is NP-complete already for cubic graphs. For a fixed value of k , the problem turns to be polynomial (i.e. the crossing number problem is fixed-parameter tractable). A naïve algorithm that runs in time $O(m^{2k+1})$ chooses k pairs of edges, subdivides each of them, identifies the two new vertices of every pair, and checks whether the new graph is planar. Significantly better theoretically, but still inappropriate for application, is the fairly recent algorithm of Grohe that answers $\text{cr}(G) \leq k$ in quadratic time for fixed k [45]. The algorithm uses bounded treewidth of crossing-critical graphs to compute a monadic second-order logic formula, which can be evaluated in linear time. Buchheim, Ebner, Jünger, Klau, Mutzel, and Weiskircher have developed an algorithm that allows exact crossing minimization for sparse graphs of order less than 40 [22]. For realistic applications to graphs of higher order, we have to rely on approximations of the crossing number. Drawings of a bounded degree graph G of order n with $O(\log^2 n(\text{cr}(G) + n))$ crossings can be obtained by combining algorithms of Bhatt and Leighton [13] with those of Chung and Yau [25], cf. [116].

Some attention has also been devoted to drawings of graphs respecting specific constraints and to various heuristics; references can be found in [132].

Let us conclude this historic overview with another controversy about crossing numbers. In Section 1.2.2, we introduced two versions of the crossing number invariant: the ordinary and the rectilinear crossing number. However, there can be more: one could count just the number of pairs of edges that cross (*the pair crossing number*), or count just those pairs of edges that cross an odd number of times (*the odd crossing number*). According to [100], the problem of seemingly mismatching definitions was first pointed out by Mohar in Burlington, Vermont, in 1995. Pach and Tóth described the problem in [92], where they observed that the result of Chojnacki [24] and Tutte [131] states that odd crossing number zero implies planarity. When these discrepancies were revealed, distinctness of the rectilinear crossing number and the ordinary one was already known: for any prescribed crossing number $k \geq 4$ Bienstock and Dean exhibited families of graphs with arbitrarily high rectilinear crossing number [14] and showed that for graphs of bounded maximum degree the rectilinear crossing number is bounded by a function of the degree and the ordinary crossing number [15]. Pach and Tóth proved that the ordinary crossing number of a graph is bounded from above by two times the square of the odd crossing number. They also extended some results about the crossing number to the odd crossing number. Recently Pelsmajer, Schaefer, and Štefankovič showed that the odd crossing number of a graph can be different from the pair crossing number and thus from the ordinary one [94]. They designed graphs for which odd crossing number does not exceed $(\frac{\sqrt{3}}{2} + o(1)) \text{cr}(G)$.

2.2 General bounds

During the study of the crossing number, three general lower bounds for the value of this invariant have emerged. They can all be traced back to Leighton's pioneering work on applications of crossing number in VLSI design [76]. We review these results in the present section.

The most straightforward general lower bound for the crossing number of a simple graph follows from the Euler Formula: if the graph has too many edges, then it cannot be planar and each excessive edge must cross some other. The Crossing Lemma uses this fact and boosts it with a probabilistic argument:

Theorem 2.1 (The Crossing Lemma). *Let G be a simple graph with n vertices and m edges, $m \geq 4n$. Then,*

$$\text{cr}(G) \geq \frac{1}{64} \frac{m^3}{n^2}.$$

Proof. Let D be an optimal drawing of G . We may assume that no pair of edges crosses twice in D and that adjacent edges do not cross. The graph of D is thus a simple graph with $\text{cr}(G) + n$ vertices and $2 \text{cr}(G) + m$ edges. The Euler Formula implies $3(\text{cr}(G) + n) - 6 \geq m + 2 \text{cr}(G)$, i.e.

$$\text{cr}(G) \geq m - 3n + 6. \quad (2.1)$$

Let D' be a random induced subdrawing of D , obtained by choosing each vertex of G with probability p . Let n', m', c' denote the random variables, respectively representing the number of vertices, edges, and crossings of D' . Inequality (2.1) holds for any drawing and we infer that $c' \geq m' - 3n'$. The same holds for the expected values of these variables. These are easy to compute: $E(n') = pn$, $E(m') = p^2m$, and $E(c') = p^4 \text{cr}(G)$. By setting $p = \frac{4n}{m}$ we obtain

$$\begin{aligned} \text{cr}(G) &\geq \frac{m}{p^2} - \frac{3n}{p^3}, \\ \text{cr}(G) &\geq \frac{m^3}{16n^2} - \frac{3m^3}{64n^2}, \\ \text{cr}(G) &\geq \frac{m^3}{64n^2}. \end{aligned}$$

□

This bound, with a general constant c in place of $\frac{1}{64}$, was conjectured by Erdős and Guy in 1973 [34]. It was proven by Leighton [76] and independently by Ajtai, Chvátal, Newborn and Szemerédi [4] for $c = \frac{1}{100}$ in 1982. The above proof emerged in an email communication between Chazelle, Sharir, and Welzl and is featured in *The Book* [3]. The result has several interesting applications outside Graph Theory, cf. Section 2.5. The constant has been improved first by Pach and Tóth [91] and then by Pach, Radoičić, Tardos, and Tóth [88]. Currently, the strongest version of the Crossing Lemma is the following:

Theorem 2.2 ([88]). *The crossing number of any simple graph G on n vertices and m edges satisfies*

$$\text{cr}(G) \geq \frac{1}{31.1} \frac{m^3}{n^2} - 1.06n.$$

If $m \geq \frac{103}{6}n$, then

$$\text{cr}(G) \geq \frac{1024}{31827} \frac{m^3}{n^2}.$$

The key improvement, which provides additional advantage over the above stated proof, is improving the bounds implied by the Euler Formula. The authors achieve this by studying drawings of sparse graphs in which every edge is crossed a bounded number of times.

Pach, Spencer, and Tóth generalized the Crossing Lemma to graphs satisfying certain monotone graph properties in [90]. Specifically, they examined high girth and forbidden complete bipartite subgraphs. They also investigated behavior of graphs with super-linear, sub-quadratic number of edges and proved the following:

Theorem 2.3 ([90]). *If $n \ll e \ll n^2$, then define*

$$\kappa(n, e) = \min_{\substack{n(G) = n \\ e(G) = e}} \text{cr}(G)$$

for simple graphs G and

$$C = \lim_{n \rightarrow \infty} \kappa(n, e) \frac{n^2}{m^3}.$$

The limit C exists and $C > 0$.

Moreover, the limit C is the same for every the surface in which we consider the crossing number.

Another general lower bound on the crossing number of a graph G employs an *embedding* f of some other graph H , $|V(H)| \leq |V(G)|$, into G : f maps vertices of H into vertices of G and edges of H into paths between corresponding vertices in G . For this reason, it is called the *embedding method* [116]. The *edge congestion* μ_f counts the maximum number of such paths running through an edge of G and the *vertex congestion* m_f a maximum number of paths through a vertex. Using these concepts, Shahrokhi and Székely prove the following:

Theorem 2.4 ([119]). *Let G be a graph of order n and f an embedding of a graph H into G . Then,*

$$\text{cr}(G) \geq \frac{\text{cr}(H)}{\mu_f^2} - \frac{n}{2} \left(\frac{m_f}{\mu_f} \right)^2.$$

This method, like the other two, can be applied to the crossing number in any orientable or nonorientable surface. The advantage is that it can be applied to multigraphs. The definitions, proofs, and some extensions can be found in [116, 117, 119]. The method generalizes an earlier work of Leighton, who used

embeddings of K_n to estimate the crossing numbers of shuffle-exchange graphs and meshes of trees [76].

The *bisection method* is the third general method for bounding the crossing numbers of graphs that we describe. The *bisection width* of a graph G is the smallest number of edges between two vertex subsets of G , each of which contains at least one third of the vertices of G . The method was first applied by Leighton, who showed the following using the planar separator theorem by Lipton and Tarjan [78]:

Theorem 2.5 ([76]). *Let G be a simple graph of order n and bounded maximum degree. Then,*

$$\text{cr}(G) + n = \Omega(b^2),$$

where b is the bisection width of G .

This theorem was sharpened by Pach, Shahrokhi, and Szegedy to use particular vertex degrees of G [89]. Sýkora and Vrtó extended the bisection method to surfaces of higher genus [120].

2.3 Exact results

The lower bounds discussed in Section 2.2 usually provide at most a correct order of magnitude of the crossing number of the graph in question, but are of little use when exact values need to be known. These are often hard to determine and standard methods do not exist. For some highly symmetric graphs, they are obtained using ad hoc arguments. The results can roughly be divided into four groups: the study of complete, complete bipartite, and similar graphs; the study of Cartesian products, in particular hypercubes and Cartesian products of two cycles; the study of generalized Petersen graphs; and the recent study of circulant graphs. All these graphs exhibit high levels of symmetry, which is used essentially in the arguments.

As mentioned in Section 2.1, the problem of the crossing numbers of complete and complete bipartite graphs roots in the very beginning of the theory of crossing numbers. The topic is dominated by the following two conjectures:

Conjecture 2.6 ([137]). *Let $n, m \geq 3$ be integers. Then,*

$$\text{cr}(K_{m,n}) = \left\lfloor \frac{n}{2} \right\rfloor \left\lfloor \frac{n-1}{2} \right\rfloor \left\lfloor \frac{m}{2} \right\rfloor \left\lfloor \frac{m-1}{2} \right\rfloor.$$

Conjecture 2.7 ([47]). *Let $n \geq 5$ be an integer. Then,*

$$\text{cr}(K_n) = \frac{1}{4} \left\lfloor \frac{n}{2} \right\rfloor \left\lfloor \frac{n-1}{2} \right\rfloor \left\lfloor \frac{n-2}{2} \right\rfloor \left\lfloor \frac{n-3}{2} \right\rfloor.$$

Conjectured optimal drawings of $K_{m,n}$ were designed by Zarankiewicz [137] and of K_n by Blažek and Koman [16], but their optimality is confirmed only for small values of parameters by Guy [46]. For K_n , these are $\text{cr}(K_n) = 0$ for $n \leq 4$, $\text{cr}(K_5) = 1$, $\text{cr}(K_6) = 3$, $\text{cr}(K_8) = 9$, $\text{cr}(K_9) = 18$, and $\text{cr}(K_{10}) = 36$. Recently, Pan and Richter announced an extension to the next two values of n : $\text{cr}(K_{11}) = 100$ and $\text{cr}(K_{12}) = 150$ [93]. For $n \leq 10$, Guy and Hill determined the crossing number of the complement of C_n , which is the complete graph K_n with a Hamilton cycle removed [48]. For complete bipartite graphs, the known results date back to 1971, when Kleitman [65] confirmed Conjecture 2.6 for all n and $3 \leq m \leq 6$. Later, Woodall [134] designed a computer based proof for $7 \leq m \leq 8$ and $7 \leq n \leq 10$. Asano established a related result: the crossing number of $K_{1,3,n}$ and $K_{2,3,n}$ [10]. Richter and Thomassen studied the asymptotics and showed that the asymptotic validity of the conjectured result for $K_{n,n}$ would imply the asymptotic validity for K_n [107]. The crossing numbers of complete and complete bipartite graphs were also studied on higher surfaces [60, 117]. The only exact results are the toroidal crossing number of K_n for $n \leq 10$ by Guy, Jenkins, and Schaer [50], and the crossing number of $K_{3,n}$ in any surface by Richter and Širáň [104], who generalized the corresponding result of Guy and Jenkins for the torus [49].

Eggleton and Guy first studied the crossing numbers of hypercubes [30]. They found an error in the announced result – which came as no surprise to the crossing number theory – and the upper bound $\text{cr}(Q_d) \leq \frac{5}{32}4^n - \left\lfloor \frac{n^2+1}{2} \right\rfloor 2^{n-2}$ became a conjecture [34]. The first proven upper and lower bounds were established by Madej [80]. Using the embedding method, Sýkora and Vrto obtained $\text{cr}(Q_d) = \Theta(4^d)$ in [121], and their lower bound is the best known to date. Madej's upper bound was first improved by Faria and Figueiredo [36]. Recently, Faria, Figueiredo, Sýkora, and Vrto described a drawing that establishes the upper bound conjectured by Erdős and Guy in [34]:

Theorem 2.8 ([37]). $\text{cr}(Q_d) \leq \frac{5}{32}4^n - \left\lfloor \frac{n^2+1}{2} \right\rfloor 2^{n-2}$ for $d \geq 3$.

Dean and Richter proved the only nonplanar exact result known [26]: Q_4 is isomorphic to $C_4 \square C_4$ and has crossing number eight.

Another view of the crossing numbers of hypercubes also attracted some interest. Kainen observed that if the genus of the surface in which Q_d is drawn is allowed to vary, then the crossing numbers seem independent of d [61]. More precisely, if Σ is a surface of genus $g(Q_d) - k$ and $k \leq \min\{g(Q_d), 2^{d-4}\}$ is a nonnegative integer, then $4k \leq \text{cr}(Q_d, \Sigma) \leq 8k$. Kainen and White proved a similar result for $Q_d \square K_{4,4}$ in [62], which Pica, Pisanski, and Ventre generalized to $Q_d \square K_{4,4} \square G$ for bipartite graphs G of maximum degree $d + 1$ [97].

The aforementioned result of Dean and Richter intersects the study of cubes with that of another difficult family of graphs: the Cartesian product $C_m \square C_n$. The best drawing of these graphs is easy to obtain, but determining its optimality proved to be a hard problem. Harary, Kainen, and Schwenk proved $\text{cr}(C_3 \square C_3) = 3$ in 1973 and conjectured $\text{cr}(C_m \square C_n) = (m-2)n$ for $3 \leq m \leq n$ [51]. For $m = 3$, this was proven by Ringeisen and Beineke using induction and an auxiliary Lemma stating that if no triangle has a crossed edge in some drawing of $C_3 \square C_n$, then the drawing has at least n crossings [108]. This paper already announces the result for $m = 4$, which was published in [12]. The proof examines distinct types of crossings and combines a careful partition of edges with an induction on n as the main tool. The topic was put aside for a decade and a half, until Klešč and, independently, Richter and Stobert established the conjecture for $m = 5$ in [71]; Richter and Salazar for $m = 6$ in [102]; and Adamsson and Richter for $m = 7$ in [2]. All of them relied on the induction as the main tool. In all of the cases $m = 3, 4, 5, 6, 7$, the base case $n = m$ was published separately [51, 26, 106, 5, 6], with the proof for $C_4 \square C_4$ appearing in [26] only after the result was used. The recent state-of-the-art on the problem is the result of Glebsky and Salazar:

Theorem 2.9 ([42]). $\text{cr}(C_m \square C_n) = (m-2)n$ for $m \geq 3$ and $n \geq \frac{1}{2}(m+1)(m+2)$.

The result relies on several insightful ideas developed prior to this paper: Richter and Thomassen established the lower bound for the crossing numbers of drawings of $C_m \square C_n$ with both families of principal cycles pairwise disjoint [106] and Salazar extended this to drawings with just one family pairwise disjoint [110]. The latter result was strengthened by Juárez and Salazar and applied to show half of the conjectured value as the best known general lower bound [58]. For $5 \leq m \leq n \leq \frac{5}{4}(m-1)$, the best lower bound $\frac{3}{5}mn$ was obtained by Shahrokhi, Sýkora, Székely, and Vrto [118]. They also proved lower bounds in the projective plane and in the Klein bottle. In their proof of Theorem 2.9, Juárez and Salazar applied the theory of arrangements introduced by Adamsson [1] and Adamsson and Richter [2], which they extended by a different assignment of crossings to the principal cycles.

There was also a substantial amount of research done on other Cartesian products besides hypercubes and $C_m \square C_n$. Beineke and Ringeisen determined the crossing number of $G \square C_n$ for any graph G of order 4, except $S_3 = K_{1,3}$ [12]. This gap was bridged by Jendrol' and Ščerbová, who determined the crossing number of $S_3 \square C_n$, $S_3 \square P_m$, and $S_4 \square P_2$ and conjectured the following:

Conjecture 2.10 ([57]). $\text{cr}(S_n \square P_m) = (m-1) \lfloor \frac{n}{2} \rfloor \lfloor \frac{n-1}{2} \rfloor$ for $n \geq 3$, $m \geq 1$.

Klešč proved this conjecture for $n = 4$ and $m \geq 1$ in [66], where he also determined $\text{cr}(S_4 \square C_m)$ for $m \geq 3$. In [70], he determined the crossing number of $G \square P_m$ and $G \square S_n$ for any graph G of order four and, in [67], the crossing number of $G \square P_m$ for any graph G of order five. For several graphs of order five, the crossing numbers of their Cartesian product with C_n or S_n are also known, as well as some other Cartesian products, most of which are due to Klešč [66, 67, 68, 69, 71]. The methods rely on the high degree of symmetry that these Cartesian products exhibit and mostly apply the following approach: if no copy of G has a sufficient amount of crossings, then enough crossings can be found in the drawing, otherwise the claim follows by induction. Also, a carefully chosen partition of edges of the Cartesian product in question is usually applied.

Generalized Petersen graphs form another family of graphs whose crossing numbers were studied. Already in 1981, Exoo, Harary, and Kabell showed $\text{cr}(P(2k+1, 2)) = 3$ for $k \geq 3$ by observing that these graphs contain a subdivision of $P(7, 2)$ and by showing that this graph has crossing number three [35]. Since the other possibilities can be easily obtained, $\text{cr}(P(n, 2))$ is known for $n \geq 3$. Fiorini has claimed to have established the crossing number of $P(8, 3)$ and subsequently $P(3k+2, 3)$, but later some doubt was shed on this result [39]. McQuillan and Richter simplified the proof for $P(8, 3)$ in [82] and later Richter and Salazar corrected an error in Fiorini's induction and established the crossing number of $P(n, 3)$ for all $n \geq 9$ in [103]. For general graphs $P(n, k)$, only the upper and lower bounds are known [114].

Another family of graphs that exhibits rich symmetry are circulant graphs and their crossing numbers have recently attracted attention from various authors. Yuansheng, Xiaohui, Jianguo, and Xin established $\text{cr}(C(n, \{1, 3\})) = \lfloor \frac{n}{3} \rfloor + (n \bmod 3)$, $n \geq 8$, in [135] and $\text{cr}(C(3k, \{1, k\})) = k$, $k \geq 3$, in [136]. Ma, Ren, and Lu established $\text{cr}(C(2m+2, m)) = m+1$, $m \geq 3$, in [79]. Also recently, the crossing numbers of some of fractal-like Sierpiński graphs were established by Klavžar and Mohar [64]. Their structure and symmetry required aid of involved algebraic arguments.

To conclude this section, we note that the asymptotics of many of the above families could be studied using the theory of tiles of Pinontoan and Richter, which we introduce later. Examples are demonstrated in [95].

2.4 Crossing-critical graphs

Crossing-critical graphs give insight into structural properties of the crossing number invariant and have thus generated considerable interest. Širáň introduced *crossing-critical edges* and proved that any such edge e of a graph G

with $\text{cr}(G - e) \leq 1$ belongs to a Kuratowsky subdivision in G [127]. Moreover, such a claim does not hold for edges with $\text{cr}(G - e) \geq 5$. In [128], Širáň constructed the first infinite family of 3-connected k -crossing-critical graphs for arbitrary given $k \geq 3$. Kochol [72] constructed the first infinite family of simple 3-connected k -crossing-critical graphs ($k \geq 2$). Richter and Thomassen proved the following:

Theorem 2.11 ([105]). $\text{cr}(G) \leq \frac{5}{2}k + 16$ for a k -crossing-critical graph G .

This result was used to prove the first in a sequence of results on vertex degrees in simple crossing-critical graphs.

Theorem 2.12 ([105]). *Let $k \geq 1$ and $r \geq 6$ be integers. There are only finitely many simple k -crossing-critical graphs with minimum degree r .*

Richter and Thomassen constructed an infinite family of simple 4-regular 4-connected 3-crossing-critical graphs and posed a question about existence of simple 5-regular k -crossing-critical graphs. Salazar observed that their argument can be extended to the average degree:

Theorem 2.13 ([111]). *Let $r > 6$ be a rational number and $k > 0$ an integer. There are only finitely many simple k -crossing-critical graphs of average degree r .*

Since the finiteness of the set of simple 3-regular k -crossing-critical graphs can be established using Robertson-Seymour graph minor theory, it follows that the only average degrees for which an infinite family of simple k -crossing-critical graphs could exist are $r \in (3, 6]$. Salazar constructed an infinite family of simple k -crossing-critical graphs with average degree r for any $r \in [4, 6)$ and posed the following question:

Question 2.14 ([111]). *Let r be a rational number in $(3, 4)$. Does there exist an integer k and an infinite family of (simple) graphs, each of which has average degree r and is k -crossing-critical?*

Question 2.14 was partially answered by Pinontoan and Richter [96]. They proposed constructing crossing-critical graphs from smaller pieces or tiles, and applied this idea to design infinite families of simple k -crossing-critical graphs for any prescribed average degree $r \in (3\frac{1}{2}, 4)$.

Salazar improved the factor $\frac{5}{2}$ in Theorem 2.11 to 2 for large k -crossing-critical graphs [112] and for graphs of minimum degree four [113].

Other structural results on crossing-critical graphs are the following theorem and corollary by Hliněný:

Theorem 2.15 ([53, 54]). *There exists a function f such that no k -crossing-critical graph contains a subdivision of a binary tree of height $f(k)$. In particular, $k - 1 \leq f(k) \leq 6(72 \log_2 k + 248)k^3$.*

Corollary 2.16 ([54]). *Let f be the function from Theorem 2.15. If G is a k -crossing-critical graph, then the path-width of G is at most $2^{f(k)+1} - 2$.*

Existence of a bound on the path-width of k -crossing-critical graphs was first conjectured by Geelen, Richter, Salazar, and Thomas in [41], where they established a result implying a bound on the tree-width of k -crossing-critical graphs.

Hliněný defined *crossed k -fences*, which are k -crossing-critical graphs, in [53]. Crossed k -fences from some particular family contain subdivisions of binary trees of height $k - 1$ and thus have path-width at least $2^k - 2$.

Focus of the research on crossing-critical graphs was on 3-(edge)-connected crossing-critical graphs. This condition eliminates vertices of degree two that are trivial with respect to the crossing number. But the condition is much stronger and its application was justified only recently by the following structural result of Leaños and Salazar:

Theorem 2.17 ([75]). *Let G be a connected crossing-critical graph with minimum degree at least three. Then there is a collection G_1, \dots, G_m of 3-edge-connected crossing-critical graphs, each of which is contained as a subdivision in G , and such that $\text{cr}(G) = \sum_{i=1}^m \text{cr}(G_i)$.*

2.5 Applications

In this section, we review applications of the crossing number invariant. They include Very Large System Integration (VLSI), approximation, discrete geometry, additive number theory, measure theory, and linguistics.

Leighton was the first to apply crossing number arguments to VLSI design [76]. He proposed several approaches to lower bounds for the crossing number (cf. Section 2.2), which he showed to have impact in the design of electronic circuits via the following two theorems:

Theorem 2.18. *Given a drawing D for a n -node graph G with c crossings it is possible to construct a layout for G with area at most $O((c+n) \log^2(c+n))$.*

Theorem 2.19. *Any circuit that computes a n -variable transitive Boolean function in time $T = o(\sqrt{n})$ must have at least c wire crossings, where $cT^2 \geq \Omega(n^2)$.*

Theorem 2.18 shows that it is worth finding drawings of graphs with few crossings. Also, one can translate lower bounds on the area of graph layouts (drawings) into lower bounds for the crossing number. Theorem 2.19 shows that graphs of fast circuits will have high crossing numbers. Further applications of the crossing number in VLSI amount mostly to obtaining good layouts of various graphs. Bhatt and Leighton designed a general algorithm for this purpose [13]. Leighton provided lower bounds on the area and the maximal edge-length of several layouts in [77]. Sýkora and Vrto established a lower bound on the crossing numbers of arrangement graphs [122] as Chockalingam did for star-connected cycles [23].

Regarding approximation, recent results of Bodlaender and Grigoriev show that several polynomial time approximation schemes for planar graphs can be extended to graphs, embeddable in some surface with only few crossings per edge [18]. These include approximation schemes for the maximum independent set problem, the minimum vertex cover problem, and the minimum dominating set problem.

Applications of the crossing number were introduced into discrete geometry through the following theorem of Szemerédi and Trotter. The original proof of this theorem was simplified by Székely using the Crossing Lemma:

Theorem 2.20 ([125],[126]). *The maximum number $I(n, m)$ of incidences between n points and m straight lines of the real plane satisfies $I(n, m) = O(n^{2/3}m^{2/3} + n + m)$.*

Proof. We may assume that each line is incident with at least one point. Let G be the graph whose vertices are the n points in which two of them are adjacent if they lie consecutively on the same line. Let D be the drawing of G in which vertices are represented by the corresponding points and edges are drawn as straight line segments between them. Each of the m lines crosses at most $m-1$ others, thus $\text{cr}(G) \leq \text{cr}(D) \leq m^2$. Each line has one incidence with a point more than there are edges drawn on it, thus there are m incidences more than there are edges in G . Now the claim follows: either $|E(G)| \leq 4n$ or Theorem 2.1 implies $m^2 \geq \text{cr}(G) \geq \frac{1}{64} \frac{(i-m)^3}{n^2}$. \square

Székely applied Theorem 2.1 in a similar way and obtained several other counting results in discrete geometry, including the following improvement of the previously best known exponent $\frac{3}{4}$:

Theorem 2.21 ([125]). *Given n points in the plane, one of them determines at least $cn^{4/5}$ distinct distances from the others.*

The theorem of Szemerédi and Trotter was applied to establish several bounds in additive number theory. Through these applications, the crossing number relates to the following results:

Theorem 2.22 ([31]). *There is a constant $c > 0$ such that the following holds for every set A of size n containing real numbers: $cn^{5/4} \leq \max\{|A+A|, |A \cdot A|\}$.*

Theorem 2.23 ([33]). *There is a positive constant c , such that $cn^{5/4} \leq |A + A^{-1}|$ for every set A of real numbers of size n .*

Other results of a similar flavor are surveyed in [32].

Perhaps the most astonishing is the following application of the crossing number in measure theory. Let μ be a probability distribution in the plane such that the probability of three μ -randomly chosen points be collinear equals zero and let $p(\mu)$ be the probability that four μ -randomly chosen points form a convex quadrilateral. In 1865, Sylvester asked about the infimum of $p(\mu)$ over all uniform distributions over open sets F with finite Lebesgue measure [123]. Only an approximation was known for the restricted case of convex F , until Scheinerman and Wilf showed the following:

Theorem 2.24 ([115]). *Let $p^* = \inf p(\mu)$, where μ runs over all probability distributions μ such that the probability of three μ -randomly chosen points be collinear equals zero and let $c^* = \lim_{n \rightarrow \infty} \frac{\text{rcrn}(K_n)}{\binom{n}{4}}$. Then, $p^* = c^*$.*

At the time of writing it is known that $0.37553 \leq c^* \leq 0.3838$. The lower bound is due to Balogh and Salazar [11] and the upper bound due to Brodsky, Durocher, and Gethner [21].

We conclude with an application that relates the crossing number even to topics outside mathematics. Let w be a word over an alphabet Σ and let G_w be the simple graph, whose vertices are elements of Σ contained in w , in which two vertices are adjacent if and only if the corresponding symbols are consecutive in w . When w is a sequence of letters in a sentence of a natural language, or a sequence of words in a text, the crossing number of G_w was proposed as a measure of complexity of the language [63]. The difficulty of this graph invariant is probably the reason that not much research has been done in this direction. Thus *eodermdromes*, which are meaningful words or sentences w with nonplanar graphs G_w , have become a domain of recreative linguistics [29].

2.6 Contribution of this thesis

We extend three areas of the theory of the crossing number in this thesis: we investigate crossing-critical graphs, prove the exact crossing numbers of several Cartesian products, and introduce a minor-monotone variant of the crossing number.

In Chapter 3, we introduce a new graph operation, the *zip product*, which combines two graphs or two drawings. We establish a sufficient connectivity condition under which the zip product preserves the crossing numbers of graphs, as well as a symmetry condition under which it preserves their criticality. The theory of *tiles* by Pinontoan and Richter [96] is extended in Chapter 4 to yield a general construction of crossing-critical graphs. In Section 4.3.2, we develop the *staircase strips*, a new gadget used to establish the crossing numbers of certain graphs. We apply them together with the zip product in Chapter 5 to design three families of crossing-critical graphs and combine them into a seven-parameter family of crossing-critical graphs using which we prove the main result of the thesis: a careful choice of parameters allows us to prescribe not only any average degree $r \in (3, 6)$, but also any sufficiently high crossing number. We thus settle Question 2.14 and combine the results of Salazar, Pinontoan and Richter with those of Širáň and Kořol.

The aforementioned constructions extend our knowledge about the structure of crossing-critical graphs in two directions. First, the staircase strips show that there exist infinite families of almost cubic 3-connected k -crossing-critical graphs with relatively few vertices of degree four. According to Richter and Salazar, similar generalizations of Kořol's 2-crossing-critical graphs were studied before, but their crossing numbers were not established until this thesis [101]. Second, Richter and Salazar observed that all known families of k -crossing-critical graphs with fixed k are built using tiles [100]. The zip product, with its ability to preserve criticality of graphs, demonstrates that the ring-like structure present in tiled k -crossing-critical graphs is not the only one: several crossing-critical graphs with such rings can be combined to yield a family of k -crossing-critical graphs, and each ring can grow independently to yield other graphs in the family. In Section 3.2, we show that criticality is contagious in the sense that performing a zip product of a crossing-critical and noncritical graph makes the edges involved in the product critical. Thus, we can turn noncritical graphs with a vertex cover satisfying a certain connectivity condition into a part of a crossing-critical graph using the zip product. Such structural consequences are discussed in Section 5.5.

Cartesian products of graphs with trees can be built recursively using the zip product. However, when applying this operation to find the crossing numbers of such products, we are left with excessive vertices corresponding to the leaves of the tree. In some cases, we can successfully eliminate them and obtain exact crossing numbers. These cases include the Cartesian product of stars $K_{1,n}$ and wheels W_n with paths, as well as some other results of similar flavor. In particular, we prove Conjecture 2.10 for any $n, m \geq 1$.

We have mentioned that drawings of graphs with few crossings are of certain importance in VLSI design. Within the setup of the ordinary crossing

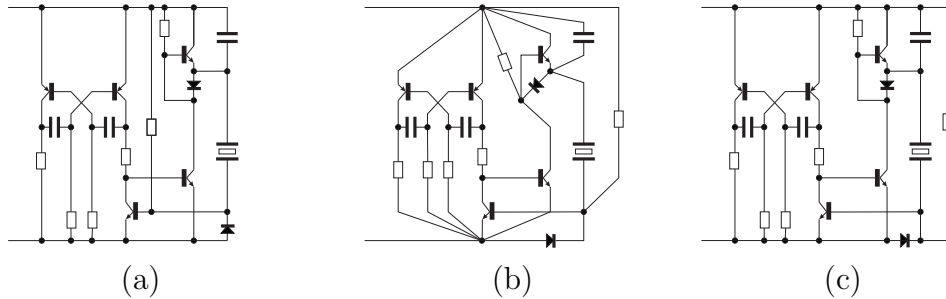

Figure 2.1: mcr and the crossing numbers of electronic circuits.

number, the goal is to minimize the number of crossings in the given graph of an electronic circuit. In this setup, we do not use the equality of the electric potential of the wires in the circuit that do not contain any electronic element. They can be contracted to a single vertex and expanded in a different manner to yield an equivalent circuit, whose graph may have smaller crossing number. We illustrate this in Figure 2.1: (a) shows the original drawing of a circuit of an ultrasonic transmitter [129], (b) shows the equivalent circuit in which all the points with the same potential are contracted to a single vertex, and (c) shows an equivalent circuit with one crossing less than (a).

The *minor crossing number* invariant that we study in Chapters 7–10 overcomes this problem. With this invariant of a graph G we seek the minimum number of crossings over all drawings of graphs that can be obtained from G by replacing its vertices with arbitrary trees. In an electronic circuit such a replacement corresponds to spreading the wires with equal potential. Thus obtained, a *realizing graph* of G has G as a minor and this variant of the crossing number is minor-monotone. It therefore solves a problem, discussed by Seymour [7], who complained: “Isn’t it a shame that crossing numbers don’t work well with minors?” Indeed, a removal of an edge never increases the crossing number, but a contraction can change it in either way.

Our studies of this new invariant focus on establishing lower bounds (Chapter 8), studying structure of graphs with bounded minor crossing numbers (Chapter 9), and on applying minor crossing number bounds to certain families of graphs (Chapter 10). Our first lower bound uses the maximum degree of a graph and establishes a sandwich theorem for the minor crossing number in terms of the ordinary crossing number. It generalizes a result of Moreno and Salazar, who proved a similar result for graphs of maximum degree four in [86]. We also bound the minor crossing number in terms of the genus of a graph and improve a bound implied by the Euler Formula by using the newly discovered structure of graphs with bounded minor crossing numbers. In addition

to several bounds for complete graphs, complete bipartite graphs, hypercubes, and Cartesian products of two cycles, we establish exact results for the minor crossing numbers of K_n , $1 \leq n \leq 8$, and of $K_{3,n}$ and $K_{4,n}$, $n \geq 3$.

Part II

Crossing-critical Graphs

Chapter 3

Zip product

In this section, we introduce the zip product, an operation on graphs and their drawings that under certain conditions preserves the crossing numbers and the criticality of graphs. We apply this operation in Chapter 5 and construct crossing-critical graphs with prescribed crossing number and average degree. Another application follows in Chapter 6, where we establish the crossing numbers of graphs of several families.

3.1 Definition and basic lemmas

For $i = 1, 2$, let G_i be a graph and let $v_i \in V(G_i)$ be its vertex of degree d . Let $N_i = N_{G_i}^*(v_i)$ be the multiplicity neighborhood of v_i and let $\sigma : N_1 \rightarrow N_2$ be a bijection. We call σ a *zip function* of graphs G_1 and G_2 at vertices v_1 and v_2 . The *zip product* of graphs G_1 and G_2 according to σ is defined to be the graph $G_1 \odot_\sigma G_2$ obtained from the disjoint union of $G_1 - v_1$ and $G_2 - v_2$ after adding the edge $u\sigma(u)$ for every $u \in N_1$. Let $G_1 \odot_{v_1 \odot v_2} G_2$ denote the set of all graphs obtained as a zip product $G_1 \odot_\sigma G_2$ for some bijection $\sigma : N_1 \rightarrow N_2$.

Let D_i be a drawing of the graph G_i and let a bijection $\pi_i : N_i \rightarrow \{1, \dots, d\}$ be a labeling respecting the edge rotation around v_i in D_i . We define $\sigma : N_1 \rightarrow N_2$, $\sigma = \pi_2^{-1}\pi_1$, to be the *zip function* of drawings D_1 and D_2 at vertices v_1 and v_2 . The *zip product* of D_1 and D_2 according to σ is the drawing $D_1 \odot_\sigma D_2$ obtained from D_1 by adding a mirrored copy of D_2 that has v_2 incident with the infinite face disjointly into some face of D_1 incident with v_1 , by removing vertices v_1 and v_2 together with small disks around them from the drawings, and then by joining the edges according to function σ , cf. Figure 3.1. As σ respects the edge rotation around v_1 and v_2 , the edges between D_1 and D_2 may be drawn without introducing any new crossings. Clearly, $D_1 \odot_\sigma D_2$ is a drawing of $G_1 \odot_\sigma G_2$. This implies the following:

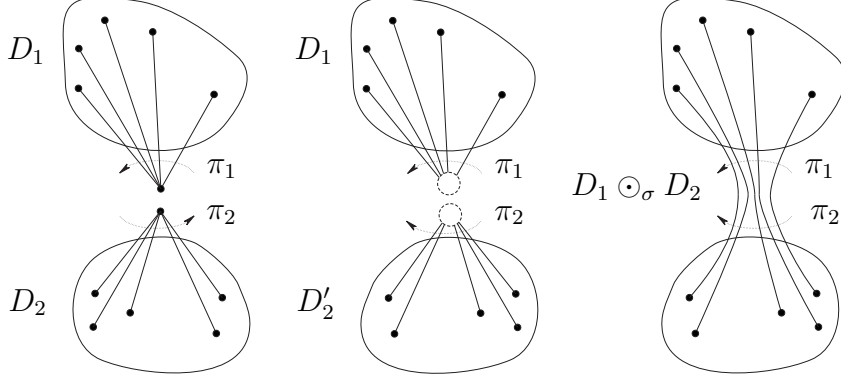

Figure 3.1: Zip product of drawings D_1 and D_2 .

Lemma 3.1. For $i = 1, 2$, let D_i be an optimal drawing of G_i , let $v_i \in V(G_i)$ be a vertex of degree d , and let σ be a zip function of D_1 and D_2 at v_1 and v_2 . Then, $\text{cr}(G_1 \odot_\sigma G_2) \leq \text{cr}(G_1) + \text{cr}(G_2)$.

Lemma 3.2. Let G_1 and G_2 be two graphs with vertices $v_1 \in V(G_1)$ and $v_2 \in V(G_2)$ of degree d , and let $G \in G_1 \odot_{v_2} G_2$. Then, $\text{cr}(G) \leq \text{cr}(G_1) + \text{cr}(G_2) + \binom{d-1}{2}$.

Proof. Let $G = G_1 \odot_\sigma G_2$. For $i = 1, 2$, let D_i be an optimal drawing of G_i . The edge rotation π_1 around v_1 in D_1 combined with σ induces a permutation π_2 of edges incident with v_2 . From D_2 , we can obtain a drawing D'_2 respecting π_2 by introducing at most $\binom{d-1}{2}$ new crossings. The drawing $D = D_1 \odot_\sigma D'_2$ of G has at most $\text{cr}(G_1) + \text{cr}(G_2) + \binom{d-1}{2}$ crossings. \square

In specific cases, the number of crossings can be further minimized using the symmetry of involved graphs.

Let $v \in V(G)$ be a vertex of degree d in G . A *bundle* of v is a set B of d edge disjoint paths from v to some vertex $u \in V(G)$, $u \neq v$. Vertex v is the *source* of the bundle and u is its *sink*. Other vertices on the paths of B are *internal vertices* of the bundle. Let $\check{E}(B) = E(B) \cap E(G - v)$ denote the set of edges of B that are not incident with v . They are called *distant edges* of B . Two bundles B_1 and B_2 of v are *coherent* if their sets of distant edges are disjoint. Edges of a bundle B that are not distant are *near edges*.

Lemma 3.3. For $i = 1, 2$, let G_i be a graph, $v_i \in V(G_i)$, $\deg(v_i) = d$, $N_i = N_{G_i}^*(v_i)$. Assume that v_2 has a bundle B in G_2 . For every bijection $\sigma : N_1 \rightarrow N_2$ and every drawing D of $G = G_1 \odot_\sigma G_2$, there are at least $\text{cr}(G_1)$ crossings in D of an edge from $E(G_1 - v_1)$ with an edge from $E(G_1 - v_1) \cup \check{E}(B) \cup \{u\sigma(u) \mid u \in N_1\}$.

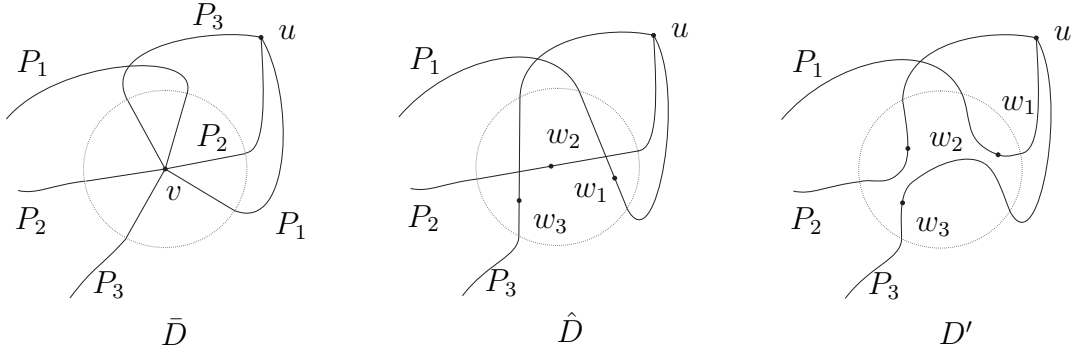

Figure 3.2: Splitting the internal vertices of a bundle.

Proof. Let \bar{G} be the subgraph of G induced by the edges of $E(G_1 - v_1) \cup \check{E}(B) \cup \{u\sigma(u) \mid u \in N_1\} \subseteq E(G)$ and let \bar{D} be the D -induced subdrawing of \bar{G} . We establish the claim by splitting some vertices of \bar{D} and producing a drawing D' of a subdivision of G_1 .

Let $u \in V(G)$ be the sink of B and $w \in V(G)$ an internal vertex of the bundle B . Assume that w lies on t paths P_1, \dots, P_t of B . We split w into t vertices w_1, \dots, w_t , such that w_j is incident precisely with the two edges of P_j incident with w . The graph \hat{G} obtained from \bar{G} after performing this split on all internal vertices of B is isomorphic to a subdivision of G_1 . From \bar{D} , we produce a drawing \hat{D} of \hat{G} by removing a small disk around every internal vertex w of B in \bar{D} and connecting the edges of paths through w in the interior of the disk (cf. Figure 3.2). We can eliminate possible new crossings by rerouting crossed pairs of paths and possibly relocating the vertices w_i inside the corresponding disks, as well as any crossing of two edges of $\check{E}(B) \cup \{u\sigma(u) \mid u \in N_1\}$, since the crossed paths emanate from the same vertex u . Let D' be the drawing of \hat{G} obtained from \hat{D} by such uncrossing. As D' is a drawing of a subdivision of G_1 and all the crossings of D' appear in D , the claim follows. \square

The process applied to the D -induced subdrawing of \bar{G} in the proof of Lemma 3.3 is called *splitting* the internal vertices of the bundle B .

Theorem 3.4. For $i = 1, 2$, let G_i be a graph, $v_i \in V(G_i)$ its vertex of degree d , and $N_i = N_{G_i}^*(v_i)$. Also assume that v_i has two coherent bundles $B_{i,1}$ and $B_{i,2}$ in G_i . Then, $\text{cr}(G_1 \odot_\sigma G_2) \geq \text{cr}(G_1) + \text{cr}(G_2)$ for any bijection $\sigma : N_1 \rightarrow N_2$.

Proof. Let $G = G_1 \odot_\sigma G_2$ and $F = \{v\sigma(v) \mid v \in N_1\} \subseteq E(G)$. For $i, j = 1, 2$, let $E_i = E(G_i - v_i) \subseteq E(G)$ and let G_{ij} be the subgraph of G spanned by the edges of E_i , $F_{ij} = \check{E}(B_{ij})$ and F .

Let D be an optimal drawing of G , and let D_{ij} be the induced subdrawing of G_{ij} . Lemma 3.3 implies $\text{cr}(G_1) \leq \text{cr}_D(E_1, E_1) + \text{cr}_D(E_1, F) + \text{cr}_D(E_1, F_{2j})$, thus also $\text{cr}(G_1) \leq \text{cr}_D(E_1, E_1) + \text{cr}_D(E_1, F) + \frac{1}{2} \text{cr}_D(E_1, F_{21} \cup F_{22})$.

A similar inequality holds for $\text{cr}(G_2)$. The sum of the two inequalities yields:

$$\begin{aligned} \text{cr}(G_1) + \text{cr}(G_2) &\leq \text{cr}_D(E_1, E_1) + \text{cr}_D(E_2, E_2) + \\ &\quad \frac{1}{2}(\text{cr}_D(E_1, F_{21} \cup F_{22}) + \text{cr}_D(E_2, F_{11} \cup F_{12})) + \\ &\quad \text{cr}_D(E_1 \cup E_2, F) \\ &\leq \text{cr}_D(E_1, E_1 \cup F) + \text{cr}_D(E_2, E_2 \cup F) + \text{cr}_D(E_1, E_2) \\ &= \text{cr}(D) - \text{cr}_D(F, F) \leq \text{cr}(G). \end{aligned}$$

Note that $F_{ij} \subseteq E_i$ are disjoint for $i, j = 1, 2$, thus a crossing of any $e \in E_1$ with some $f \in E_2$ is counted at most twice in the sum of $\text{cr}_D(E_i, F_{3-i,j})$. This justifies the second inequality. \square

If one of the graphs is planar, we need only one bundle.

Lemma 3.5. *For $i = 1, 2$, let G_i be a graph, $v_i \in V(G_i)$ its vertex of degree d , and $N_i = N_{G_i}^*(v_i)$. Assume that G_1 is planar and that v_1 has a bundle B_1 in G_1 . Then, $\text{cr}(G_1 \odot_\sigma G_2) \geq \text{cr}(G_2)$ for any bijection $\sigma : N_1 \rightarrow N_2$. Equality holds if, for $i = 1, 2$, σ respects the edge rotation around v_i in some optimal drawing D_i of G_i .*

Proof. Since v_1 has a bundle in G_1 , any drawing of $G = G_1 \odot_\sigma G_2$ can be turned into a drawing of a subdivision of G_2 by splitting the bundle B . The lower bound follows. If σ respects the edge rotation around v_1 and v_2 , then the drawing $D = D_1 \odot_\sigma D_2$ contains only the crossings of D_2 and the claim follows. \square

We use the following observations in iterative applications of the zip product.

Lemma 3.6. *Let G_1 and G_2 be disjoint graphs, $v_i \in V(G_i)$, $\deg_{G_i}(v_i) = d$, and $G \in G_1 \odot_{v_1} \odot_{v_2} G_2$.*

- (i) *If v_2 has a bundle in G_2 and $v \in V(G_1)$ has k pairwise coherent bundles in G_1 , then v has k pairwise coherent bundles in G .*
- (ii) *If, for $i = 1, 2$, the graph G_i is k_i -connected, $k_i \geq 2$, then G is k -connected for $k = \min(k_1, k_2)$.*
- (iii) *If, for $i = 1, 2$, the graph G_i is k_i -edge-connected, $k_i \geq 2$, then G is k -edge-connected for $k = \min(k_1, k_2)$.*

Proof. (i): Assume $G = G_1 \odot_\sigma G_2$ and let B_1, \dots, B_k be the bundles of v in G_1 and B the bundle of v_2 in G_2 . For an edge $e = uv_2$, let P_e be the path of B containing e . A path $P \in \bigcup_{i=1}^k B_i$ can have at most two edges that are in P incident with v_1 . If there are none, define $P' = P$. If there is only one such edge wv_1 , define $P' = Pw\sigma(w)P_e$, $e = \sigma(w)v_2$. For two such edges $wv_1 \neq zv_1$ on P , define $P' = Pw\sigma(w)P_eP_f\sigma(z)zP$, $e = \sigma(w)v_2$, $f = \sigma(z)v_2$. As the paths of B are pairwise edge disjoint and each of them is used at most once in the construction of some P' , the paths P'_1 and P'_2 are edge disjoint for edge disjoint paths $P_1, P_2 \in \bigcup_{i=1}^k B_i$. If P_1, P_2 in G_1 share only the edge incident with v , so do P'_1 and P'_2 in G . If $u \neq v_1$ is the endvertex of the path $P \in \bigcup_{i=1}^k B_i$, then u is the endvertex of P' . If v_1 is the endvertex of the path $P \in \bigcup_{i=1}^k B_i$, then the endvertex of P' is the sink of B . These three statements imply that the sets $B'_i = \{P' \mid P \in B_i\}$, $i = 1, \dots, k$, are pairwise coherent bundles of v in G .

(ii): Let $S \subseteq V(G)$ be a separator of G . If $S \subseteq G_i - v_i$, then, as $G_{3-i} - v_{3-i}$ is nonempty and $(k_{3-i} - 1)$ -connected, S is a separator in G_i and $|S| \geq k$. Let $S_i = S \cap G_i - v_i$ and $S_i \neq \emptyset$ for $i = 1, 2$. If $S_i \cup v_i$ is a separator in G_i for one of $i = 1, 2$, then $|S| \geq k$. Otherwise, the vertices of $G_i - v_i - S$ are all in the same component of $G - S$ for both $i = 1, 2$, thus $|S| \geq d \geq k$.

(iii): The argument is similar to (ii). □

3.2 Homogeneity condition

In this section, we introduce a sufficient condition for the zip product to preserve criticality of graphs.

Let $S \subset V(G)$ be a set and $\Gamma \subseteq \text{Aut}(G)$ a group. We say that S is Γ -homogeneous in G if any permutation π of S can be extended to an automorphism $\sigma \in \Gamma$. For $S \subseteq V(G)$, let $\Gamma(S)$ be the pointwise stabilizer of S in $\text{Aut}(G)$. We say that a vertex $v \in V(G)$ has a *homogeneous neighborhood* in G if $N_G(v)$ is $\Gamma(\{v\})$ -homogeneous in G .

If all the vertices in $N_G(v)$ have the same set of neighbors for a vertex $v \in V(G)$, then v has a homogeneous neighborhood G . Thus, every vertex of a complete or complete bipartite graph K has a homogeneous neighborhood in K .

A vertex v in a graph G is *semiactive* if it has two coherent bundles in G . If, in addition, v has no incident multiple edges and has a homogeneous neighborhood, then v is *active*. $\mathcal{S}(G)$ and $\mathcal{A}(G)$ respectively denote the sets of semiactive and active vertices of G .

Theorem 3.7. *For $i = 1, 2$, let G_i be a graph with a vertex $v_i \in V(G_i)$ of degree d . If $v_1 \in \mathcal{S}(G_1)$ and $v_2 \in \mathcal{A}(G_2)$, then the following holds for every*

graph $G \in G_1 \circ_{v_1, v_2} G_2$:

(i) $\text{cr}(G) = \text{cr}(G_1) + \text{cr}(G_2)$.

If, in addition, $v_1 \in \mathcal{A}(G_1)$, then:

(ii) If, for $i = 1, 2$, the graph G_i is k_i -crossing-critical, then G is k -crossing-critical for $k = \max \{ \text{cr}(G_i) + k_{3-i} \mid i \in \{1, 2\} \}$.

(iii) If, for $j \in \{1, 2\}$, $v \in \mathcal{A}(G_j)$, $v \neq v_j$, and $N_{G_j}(v)$ is $\Gamma_{G_j}(\{v, v_j\})$ -homogeneous, then $v \in \mathcal{A}(G)$.

Proof. For the proof, assume $N_1 = N_{G_1}^*(v_1)$, $N_2 = N_{G_2}^*(v_2)$, and let the zip function of G be $\sigma : N_1 \rightarrow N_2$.

(i): For $i = 1, 2$, let D_i be an optimal drawing of G_i and let π_i denote the vertex rotation around v_i in D_i . Because there exists an automorphism $\rho \in \Gamma_{G_2}(\{v_2\})$ with $\rho/N_2 = \sigma\pi_1\sigma^{-1}\pi_2^{-1}$, we can rearrange the vertices in D_2 using ρ and obtain a drawing D'_2 of G_2 with $\text{cr}(D_2)$ crossings in which the vertex rotation of v_2 is $\sigma\pi_1\sigma^{-1}$. Since v_2 has no multiple edges, Claim (i) follows by Lemma 3.1 and Theorem 3.4.

(ii): Claim (i) implies $\text{cr}(G) \geq k$. Let $e \in E(G)$, and assume $e \in E(G_1 - v_1)$. Let D_1 be an optimal drawing of $G_1 - e$ and D_2 an optimal drawing of G_2 . We adjust D_2 using the appropriate automorphism in $\Gamma_{G_2}(\{v_2\})$ similarly as in the proof of (i) and combine D_2 with D_1 to produce a drawing of $G - e$ with at most k crossings. Similar arguments apply for $e \in E(G_2 - v_2)$.

If $e = v\sigma(v)$ for $v \in N_1$, let D_1 be an optimal drawing of $G_1 - vv_1$ and D_2 an optimal drawing of $G_2 - v_2\sigma(v)$. Let π_1 be the vertex rotation around v_1 in D_1 and $\rho \in \Gamma_{G_2}(\{v_2\})$ an automorphism of G_2 with $\rho/(N_2 \setminus \{\sigma(v)\}) = \sigma\pi_1\sigma^{-1}$. The vertices of N_2 can be rearranged with ρ as in the proof of (i), thus by Lemma 3.1, $G - e$ can be drawn with at most $k_1 + k_2$ crossings.

(iii): Assume that $j = 1$, case $j = 2$ is similar. Due to $v \in \mathcal{S}(G_1)$, Lemma 3.6 (i) implies $v \in \mathcal{S}(G)$. For a permutation π of $N = N_{G_j}(v)$, there exists $\sigma_1 \in \Gamma_{G_1}(\{v, v_1\})$, such that $\sigma_1/N = \pi$. Let $\pi_1 = \sigma_1/N_1$, and set $\pi_2 = \sigma\pi_1\sigma^{-1}$. As $v_2 \in \mathcal{A}(G_2)$, there exists an automorphism $\sigma_2 \in \Gamma_{G_2}(v_2)$ with $\sigma_2/N_2 = \pi_2$. It is easy to verify that a function $\Phi : G \rightarrow G$ with $\Phi/(G_i - v_i) = \sigma_i/(G_i - v_i)$, for $i = 1, 2$, is an automorphism of $\Gamma_G(v)$, for which $\Phi/N = \pi$. Thus, v has a homogeneous neighborhood in G . The claim (iii) follows. \square

Note that we did not apply rotation and mirroring of the drawings in our proofs of (i) and (ii). These operations relax the condition that $\text{Aut}(G)$ acts as a full symmetric group on the neighborhoods. Some specific examples where the relaxed condition applies will be studied in Chapter 6, but we believe that vertices of degree three are the only interesting general example, as the

dihedral group of order three is equal to the full symmetric group of this order. The argument does not extend in (iii).

Theorem 3.8. *For $i = 1, 2$, let G_i be two graphs with vertices $v_i \in V(G_i)$ of degree three. If $v_i \in \mathcal{S}(G_i)$, then the following hold for every graph $G \in G_1 v_1 \odot_{v_2} G_2$:*

$$(i) \quad \text{cr}(G) = \text{cr}(G_1) + \text{cr}(G_2),$$

(ii) *If, for $i = 1, 2$, G_i is k_i -crossing-critical, then G is k -crossing-critical for $k = \max \{ \text{cr}(G_i) + k_{3-i} \mid i \in \{1, 2\} \}$.*

Argument of Theorem 3.7 (ii) has a generalization to (not necessarily critical) graphs that have a vertex cover consisting of semiactive vertices of degree three. Let G be a graph and $S = \{v_1, \dots, v_t\} \subseteq V(G)$. For each $v_i \in S$, let G_i be a graph and let $u_i \in V(G_i)$ be a vertex of degree $d(u_i) = d(v_i)$. Let $\mathcal{S} := \{(v_i, G_i) \mid i \in \{1, \dots, t\}\}$. The family $G^{\mathcal{S}} := \Gamma^t$ is defined inductively as follows: $\Gamma^0 = \{G\}$, and, for $i = 1, \dots, t$, let $\Gamma^i := \bigcup_{H \in \Gamma^{i-1}} H v_i \odot_{u_i} G_i$. Further, let $\mathcal{S}_i := \mathcal{S} \setminus \{(v_i, G_i)\}$.

Theorem 3.9. *Let G be a graph, S its vertex cover consisting of semiactive vertices of degree three, and \mathcal{S} defined as above. If, for $i = 1, \dots, t$, the graph G_i is k_i -crossing-critical, then every $\bar{G} \in G^{\mathcal{S}}$ is k -crossing-critical for $k = \max \{ \text{cr}(\bar{G}) - \text{cr}(G_i) + k_i \mid i \in \{1, \dots, t\} \}$ and has crossing number $\text{cr}(\bar{G}) = \text{cr}(G) + \sum_{i=1}^t \text{cr}(G_i)$.*

Proof. Iterative application of Theorem 3.8 (i) implies $\text{cr}(\bar{G}) = \text{cr}(G) + \sum_{i=1}^t \text{cr}(G_i)$. To establish criticality of \bar{G} , let $e \in E(G^{\mathcal{S}})$ be an arbitrary edge and let $\bar{G}_j \in G^{\mathcal{S}_j}$, $j = 1, \dots, t$, be the graph, such that $\bar{G} \in \bar{G}_j v_j \odot_{u_j} G_j$.

Case 1: Assume $e \in E(G_j - v_j)$ for some $j \in \{1, \dots, t\}$. Let D_1 be an optimal drawing of \bar{G}_j with v_j in the infinite face and let D_2 be an optimal drawing of $G_j - e$ with u_j in the infinite face. We can combine $D_1 - v_j$ and $D_2 - u_j$ into a drawing D of $G - e$. By Theorem 3.8 (i), D has at most $\text{cr}(G) + k_j + \sum_{i \neq j} \text{cr}(G_i) \leq k$ crossings.

Case 2: Assume $e \notin E(G_i - v_i)$ for any $i \in \{1, \dots, t\}$. As S is a vertex cover in G , there exists $j \in \{1, \dots, t\}$, such that e connects some neighbor x of $u_j \in V(G_j)$ with some neighbor y of v_j in \bar{G}_j . Let $e_1 = v_j y \in E(\bar{G}_j)$, $e_2 = u_j x \in E(G_j)$, and let D_1 be an optimal drawing of $\bar{G}_j - e_1$ with v_j on the infinite face and D_2 an optimal drawing of $G_j - e_2$ with u_j in the infinite face. We can combine $D_1 - v_j$ and $D_2 - u_j$ into a drawing D of $G - e$. By Theorem 3.8 (i), D has at most $\text{cr}(G - e) + k_j + \sum_{i \neq j} \text{cr}(G_i) \leq k$ crossings. \square

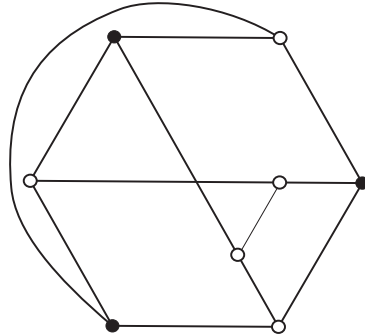

Figure 3.3: Graph with a vertex cover of cubic vertices each having two coherent bundles.

Having a vertex cover consisting of cubic vertices with two coherent bundles seems a strong condition and one may think it forces the graph to be crossing-critical. This, however, is not the case: the white vertices of the graph G in Figure 3.3 form such a vertex cover, but since $\text{cr}(G) = 1$ and not all the edges lie in the $K_{3,3}$ subdivision in G , this graph is not crossing-critical.

Leaños and Salazar established a decomposition of 2-connected crossing-critical graphs into smaller 3-connected crossing-critical graphs in Theorem 2.17. Theorem 3.9, in combination with Figure 3.3, suggests that a similar decomposition does not exist for 3-connected crossing-critical graphs.

Chapter 4

Tiles

In this chapter, we present a variant of the theory of tiles developed by Pinontoan and Richter [96]. In particular, we consider general sequences of not necessarily equal tiles, avoid the condition that the tiles be connected, and allow forming double edges when joining tiles. Such generalizations do not hinder the arguments of [96] and are useful in further investigations of tiled graphs. We establish an effective bound on the number of tiles needed to imply lower bounds on crossing numbers. Finally, we combine these improvements into a general construction of crossing-critical graphs.

4.1 Definition and basic lemmas

Let G be a graph and $\lambda = (\lambda_0, \dots, \lambda_l)$, $\rho = (\rho_0, \dots, \rho_r)$ two sequences of distinct vertices, such that no vertex of G appears in both. The triple $T = (G, \lambda, \rho)$ is called a *tile*. To simplify the notation, we may sometimes use T in place of its graph G and we may consider sequences λ and ρ as sets of vertices. For $u, v \in \lambda$ or $u, v \in \rho$, we use $u \leq v$ or $u \geq v$ whenever u precedes or succeeds v in the respective sequence.

A drawing of G in the unit square $[0, 1] \times [0, 1]$ that meets the boundary of the square precisely in the vertices of the *left wall* λ , all drawn in $\{0\} \times [0, 1]$, and the *right wall* ρ , all drawn in $\{1\} \times [0, 1]$, is a *tile drawing* of T if the sequence of decreasing y -coordinates of the vertices of each λ and ρ respects the corresponding sequence λ or ρ . The *tile crossing number* $\text{tcr}(T)$ of a tile T is the minimum crossing number over all tile drawings of T .

Let $T = (G, \lambda, \rho)$ and $T' = (G', \lambda', \rho')$ be two tiles. We say that T is *compatible* with T' if $|\rho| = |\lambda'|$. A tile T is *cyclically-compatible* if it is compatible with itself. A sequence of tiles $\mathcal{T} = (T_0, \dots, T_m)$ is *compatible* if T_i is compatible with T_{i+1} for $i = 0, \dots, m - 1$. It is *cyclically-compatible* if it is

compatible and T_m is compatible with T_0 . All sequences of tiles are assumed to be compatible.

The *join* of two compatible tiles T and T' is defined as $T \otimes T' = (G \otimes G', \lambda, \rho')$, where $G \otimes G'$ is the graph obtained from the disjoint union of G and G' by identifying ρ_i with λ'_i for $i = 0, \dots, |\rho| - 1$. This operation is associative, thus we can define the *join* of a compatible sequence of tiles $\mathcal{T} = (T_0, \dots, T_m)$ to be the tile $\otimes\mathcal{T} = T_0 \otimes T_1 \otimes \dots \otimes T_m$. Note that we may produce multiple edges or vertices of degree two when joining tiles. We keep the double edges, but remove the vertices of degree two by contracting one of the incident edges.

For a cyclically-compatible tile $T = (G, \lambda, \rho)$, we define its *cyclization* $\circ T$ as the graph, obtained from G by identifying λ_i with ρ_i for $i = 0, \dots, |\rho| - 1$. Similarly, we define the cyclization of a cyclically-compatible sequence of tiles as $\circ\mathcal{T} = \circ(\otimes\mathcal{T})$.

The *suspension* of a tile $T = (G, \lambda, \rho)$ is the graph T^* , which is obtained from T by adding a new vertex v (called the *apex* of T^*) to G and connecting it precisely to all the vertices of $\lambda \cup \rho$. Note that neither the cyclization nor the suspension of a tile is a tile.

Lemma 4.1 ([96]). *Let T be a tile. Then, $\text{cr}(T^*) \leq \text{tcr}(T)$. Let T be a cyclically-compatible tile. Then, $\text{cr}(\circ T) \leq \text{tcr}(T)$. Let $\mathcal{T} = (T_0, \dots, T_m)$ be a compatible sequence of tiles. Then, $\text{tcr}(\otimes\mathcal{T}) \leq \sum_{i=0}^m \text{tcr}(T_i)$.*

For a sequence ω , let $\bar{\omega}$ denote the reversed sequence. For a tile $T = (G, \lambda, \rho)$, let its *right-inverted* tile T^\downarrow be the tile $(G, \lambda, \bar{\rho})$, its *left-inverted* tile ${}^\downarrow T$ be the tile $(G, \bar{\lambda}, \rho)$, and its *inverted* tile be the tile ${}^\downarrow T^\downarrow = (G, \bar{\lambda}, \bar{\rho})$. The *reversed* tile of T is the tile $T^{\leftrightarrow} = (G, \rho, \lambda)$.

Let $\mathcal{T} = (T_0, \dots, T_m)$ be a sequence of tiles. A *reversed* sequence of \mathcal{T} is the sequence $\mathcal{T}^{\leftrightarrow} = (T_m^{\leftrightarrow}, \dots, T_0^{\leftrightarrow})$. A *twist* of \mathcal{T} is the sequence $\mathcal{T}^\uparrow = (T_0, \dots, T_{m-1}, T_m^\uparrow)$. Let $i = 0, \dots, m$. Then, an *i-flip* of \mathcal{T} is the sequence $\mathcal{T}^i = (T_0, \dots, T_{i-1}, T_i^\downarrow, {}^\downarrow T_{i+1}, T_{i+2}, \dots, T_m)$, an *i-cut* of \mathcal{T} is the sequence $\mathcal{T}/i = (T_{i+1}, \dots, T_m, T_0, \dots, T_{i-1})$, and an *i-shift* of \mathcal{T} is the sequence $\mathcal{T}_i = (T_i, \dots, T_m, T_0, \dots, T_{i+1})$. For the last two operations, cyclic compatibility of \mathcal{T} is required.

Two sequences of tiles \mathcal{T} and \mathcal{T}' of the same length m are *equivalent* if one can be obtained from the other by a sequence of shifts, flips, and reversals. It is easy to see that the graphs $\circ\mathcal{T}$ and $\circ\mathcal{T}'$ are equal for equivalent cyclically-compatible sequences \mathcal{T} and \mathcal{T}' and thus have the same crossing number.

4.2 Properties of tiles

We say that a tile $T = (G, \lambda, \rho)$ is *planar* if $\text{tcr}(T) = 0$ holds. It is *connected* if G is connected. It is *perfect* if:

- (p.i) $|\lambda| = |\rho|$,
- (p.ii) both graphs $G - \lambda$ and $G - \rho$ are connected,
- (p.iii) for every $v \in \lambda$ or $v \in \rho$ there is a path from v to a vertex in ρ (λ) in G internally disjoint from λ (ρ), and
- (p.iv) for every $0 \leq i < j \leq |\lambda|$ there is a pair of disjoint paths P_{ij} and P_{ji} in G , such that P_{ij} joins λ_i with ρ_i and P_{ji} joins λ_j with ρ_j .

Note that perfect tiles are connected.

Lemma 4.2 ([96]). *For a cyclically-compatible perfect planar tile T and a compatible sequence $\mathcal{T} = (T_0, \dots, T_m, T)$, there exists $n \in \mathbb{N}$, such that for every $k \geq n$, $\text{tcr}((\otimes \mathcal{T}) \otimes (T^k)) = \text{tcr}((\otimes \mathcal{T}) \otimes (T^n))$.*

Let $T = (G, \lambda, \rho)$ be a tile and H a graph that contains G as a subgraph. The *complement* of the tile T in H is the tile $H - T = (H[(V(H) \setminus V(G)) \cup \lambda \cup \rho] - E(G), \rho, \lambda)$. We can consider it as the edge complement of the subgraph G of H from which we remove all the vertices of T not in its walls. Whenever $\circ(T \otimes (H - T)) = H$, i.e. if the vertices of $\lambda \cup \rho$ separate G from $H - G$, we say that T is a *tile in H* . Using this concept, the following lemma shows the essence of perfect tiles.

Lemma 4.3. *Let $T = (G, \lambda, \rho)$ be a perfect planar tile in a graph H , such that there exist two disjoint connected subgraphs G_λ and G_ρ of H contained in the same component of $H - T$ and with $G \cap G_\lambda = (\lambda, \emptyset)$, $G \cap G_\rho = (\rho, \emptyset)$. If $E(G)$ and either $E(G_\lambda)$ or $E(G_\rho)$ are not crossed in some drawing D of H , then the D -induced drawings of T and its complement $H - T$ are homeomorphic to tile drawings.*

Proof. There is only one component of $H - T$ containing the vertices of $\lambda \cup \rho$, and as the edges of other components do not cross G nor influence its induced drawing, we may assume that $H - T$ is that component and, in particular, it is connected.

Denote by D_T the D -induced drawing of T , by T^- the tile $H - T$, and by D^- the D -induced drawing of T^- . As the edges of T are not crossed in D and T^- is connected, there is a face F of D_T containing D^- . The boundary of F contains all vertices of $T \cap T^- = \lambda \cup \rho$. Let W be the facial walk of F .

No vertex of $\lambda \cup \rho$ appears twice in W : such a vertex would be a cutvertex in the planar graph G . Then either $G - \lambda$ or $G - \rho$ would not be connected, violating (p.ii), or some vertex in $\lambda \cup \rho$ would have no path to the opposite wall satisfying (p.iii).

Let W' be the induced sequence of vertices of $\lambda \cup \rho$ in W . As the edges of G_λ or G_ρ are not crossed in D and T , G_λ , and G_ρ are connected, the vertices of λ do not interlace with the vertices of ρ in W' . The ordering of λ in W' is the inverse ordering of ρ in W' , since the disjoint paths from (p.iv) do not cross in D_T . The planarity and the connectedness of T imply that whenever $i < j < l$ or $i > j > l$, there is a path Q from P_{jl} to λ_i disjoint from P_{lj} . Q does not cross P_{lj} in D_T , thus $W' = \lambda\bar{\rho}$ or $W' = \rho\bar{\lambda}$. The claim follows. \square

The above arguments were in [96] combined with Lemma 4.2 to demonstrate the following:

Theorem 4.4 ([96]). *Let T be a perfect planar tile and for $k \geq 1$ let $\bar{T}_k = T^k \otimes T^\dagger \otimes T^k$. Then there exist integers n, N , such that $\text{cr}(\circ(\bar{T}_k)) = \text{tcr}(\bar{T}_n)$ for every $k \geq N$.*

We establish effective values of n and N from the above theorem:

Theorem 4.5. *Let $\mathcal{T} = (T_0, \dots, T_l, \dots, T_m)$ be a cyclically-compatible sequence of tiles. Assume that for some integer $k \geq 0$ the following hold: $m \geq 4k - 2$, $\text{tcr}(\otimes\mathcal{T}/i) \geq k$, and the tile T_i is a perfect planar tile, both for every $i = 0, \dots, m$, $i \neq l$. Then, $\text{cr}(\circ\mathcal{T}) \geq k$.*

Proof. We may assume $k \geq 1$. Let $G = \circ\mathcal{T}$ and let D be an optimal drawing of G . Assume that D has less than k crossings. Then there are at most $2k - 1$ tiles in the set $\mathcal{S} = \{T_i \mid i = l \text{ or } E(T_i) \text{ crossed in } D\}$. The circular sequence \mathcal{T} is by the tiles of \mathcal{S} fragmented into at most $2k - 1$ segments. By the pigeonhole principle the set $\mathcal{T} \setminus \mathcal{S}$, which consists of at least $2k$ tiles, contains two consecutive tiles $T_i T_{i+1}$. Assume for simplicity that $i = 1$, then either T_0 or T_3 is distinct from T_l . Lemma 4.3 with (G, T_1, T_0, T_2) or (G, T_2, T_1, T_3) in place of $(H, T, G_\lambda, G_\rho)$ establishes that the induced drawing D^- of $G - T_j$ is a tile drawing for some $j \in \{1, 2\}$. Since D^- contains all the crossings of D , this contradicts $\text{tcr}(\otimes(\mathcal{T}/j)) \geq k$, and the claim follows. \square

Corollary 4.6. *Let $\mathcal{T} = (T_0, \dots, T_l, \dots, T_m)$ be a cyclically-compatible sequence of tiles and $k = \min_{i \neq l} \text{tcr}(\otimes\mathcal{T}/i)$. If $m \geq 4k - 2$ and the tile T_i is a perfect planar tile for every $i = 0, \dots, m$, $i \neq l$, then $\text{cr}(\circ\mathcal{T}) = k$.*

Proof. By Lemma 4.1 and the planarity of tiles, $\text{cr}(\circ\mathcal{T}) \leq \text{tcr}((\otimes\mathcal{T}/i) \otimes T_i) \leq \text{tcr}(\otimes\mathcal{T}/i)$ for any $i \neq l$, thus $\text{cr}(\circ\mathcal{T}) \leq k$. Theorem 4.5 establishes k as a lower bound and the claim follows. \square

A tile T is *k-degenerate* if it is perfect, planar, and $\text{tcr}(T^\downarrow - e) < k$ for any edge $e \in E(T)$. A sequence of tiles $\mathcal{T} = (T_0, \dots, T_m)$ is *k-critical* if the tile T_i is *k-degenerate* for every $i = 0, \dots, m$ and $\min_{i \neq m} \text{tcr}(\otimes(\mathcal{T}^\downarrow/i)) \geq k$. Note that $\text{tcr}(T^\downarrow) \geq k$ for every tile T in a *k-critical* sequence.

Corollary 4.7. *Let $\mathcal{T} = (T_0, \dots, T_m)$ be a *k-critical* sequence of tiles. Then, $T = \otimes\mathcal{T}$ is a *k-degenerate* tile. If $m \geq 4k - 2$ and \mathcal{T} is *cyclically-compatible*, then $\circ(T^\downarrow)$ is a *k-crossing-critical* graph.*

Proof. Lemma 4.1 implies that T is a planar tile. By induction it is easy to show that T is a perfect tile. Let e be an edge of T and let i be such that $e \in T_i$. The sequence $\mathcal{T}' = (T_0, \dots, T_{i-1}, T_i^\downarrow, \uparrow T_{i+1}^\downarrow, \dots, \uparrow T_m^\downarrow)$ is equivalent to \mathcal{T}^\downarrow . Lemma 4.1 establishes $\text{tcr}(T^\downarrow - e) = \text{tcr}((\otimes\mathcal{T}') - e) \leq \text{tcr}(T_i^\downarrow - e) < k$, thus T is a *k-degenerate* tile.

Let \mathcal{T} be *cyclically-compatible*. Then $\text{cr}((\circ T^\downarrow) - e) < k$ for any edge $e \in E(T)$. Theorem 4.5 implies $\text{cr}(\circ(T^\downarrow)) \geq k$ for $m \geq 4k - 2$. Thus, $\circ(T^\downarrow)$ is a *k-crossing-critical* graph. \square

4.3 Gadgets in tiles

Results of Section 4.2 provide sufficient conditions for the crossing numbers of certain graphs to be estimated in terms of the tile crossing numbers of their subgraphs. This section develops some techniques to estimate the tile crossing number.

A general tool we employ for this purpose is the concept of a *gadget*. We do not define it formally; a gadget can be any structure inside a tile $T = (G, \lambda, \rho)$, which guarantees a certain number of crossings in every tile drawing of T . Four specific types of gadgets are presented: twisted pairs, staircase strips, cloned vertices, and wheel gadgets. We supplement them by related results that point out the principles using which new gadgets could be defined.

In general, there can be many gadgets inside a single tile. Whenever they are edge disjoint, the crossings they force in tile drawings are distinct. The following weakening of disjointness enables us to prove stronger results. For clarity we first state the condition in its set-theoretic form.

Let A_1, B_1, A_2, B_2 be four sets. The unordered pairs $\{A_1, B_1\}$ and $\{A_2, B_2\}$ are *coherent* if one of the sets X_i , $X \in \{A, B\}$, $i \in \{1, 2\}$, is disjoint from $A_{3-i} \cup B_{3-i}$.

Lemma 4.8. *Let $\{A, B\}$ and $\{A', B'\}$ be two pairs of sets. If they are coherent and*

$$a \in A, b \in B, a' \in A' \text{ and } b' \in B', \quad (4.1)$$

then the unordered pairs $\{a, b\}$ and $\{a', b'\}$ are distinct. Conversely, if (4.1) implies distinctness of $\{a, b\}$, $\{a', b'\}$ for every quadruple a, b, a', b' , then the pairs $\{A, B\}$, $\{A', B'\}$ are coherent.

Proof. Suppose the pairs are not distinct, then either $a = a'$ and $b = b'$, or $a = b'$ and $b = a'$. In both cases, every set has a member in the union of the other pair, and the pairs are not coherent.

For the converse, suppose the pairs would not be coherent. Then every set would contain an element in the union of the opposite pair. Let $x \in A \cap A'$, assuming the intersection is not empty. If there is an element $y \in B' \cap B$, then the quadruple $a = x, b = y, a' = x, b' = y$ satisfies (4.1) but does not form two distinct pairs. If $B \cap B'$ is empty, then there must be $a' \in B \cap A'$ and $b' \in B' \cap A$. The quadruple $a = a', b = b', a', b'$ satisfies (4.1). Assuming $x \in A \cap B'$, a similar analysis applies and the claim follows. \square

Lemma 4.8 has an immediate application to crossings: whenever the pairs of edges $\{e_x, f_x\}$ and $\{e_y, f_y\}$ are distinct for two crossings x and y , the crossings x and y are distinct. Distinctness of crossings induced by two coherent pairs of sets of edges in a graph follows.

The notion of coherence can be generalized. Let $\{A_1, \dots, A_m\}$ and $\{B_1, \dots, B_n\}$ be two families of sets. They are *coherent* if the two pairs $\{A_i, A_j\}$ and $\{B_k, B_l\}$ are coherent for every $0 \leq i < j \leq m, 0 \leq k < l \leq n$.

4.3.1 Twisted pairs

A path P in G is a *traversing path* in a tile $T = (G, \lambda, \rho)$ if there exist indices $i(P) \in \{0, \dots, |\lambda| - 1\}$ and $j(P) \in \{0, \dots, |\rho| - 1\}$ such that P is a path from $\lambda(P) = \lambda_{i(P)}$ to $\rho(P) = \rho_{j(P)}$ and $\lambda(P), \rho(P)$ are the only wall vertices that lie on P . An (unordered) pair of disjoint traversing paths $\{P, Q\}$ is *aligned* if $i(P) < i(Q)$ is equivalent to $j(P) < j(Q)$, and *twisted* otherwise. Disjointness of the traversing paths in a twisted pair $\{P, Q\}$ implies that some edge of P must cross some edge of Q in any tile drawing of T . Two pairs $\{P, Q\}$ and $\{P', Q'\}$ of traversing paths in T are *coherent* if $\{E(P), E(Q)\}$ and $\{E(P'), E(Q')\}$ are coherent. A family of pairwise coherent twisted (respectively, aligned) pairs of traversing paths in a tile T is called a *twisted (aligned) family* in T .

Lemma 4.9 ([96]). *Let \mathcal{F} be a twisted family in a tile T . Then, $\text{tcr}(T) \geq |\mathcal{F}|$.*

Let a tile T be compatible with T' and let $\{P, Q\}$ be a twisted pair of traversing paths of T . An aligned pair $\{P', Q'\}$ of traversing paths in T' extends $\{P, Q\}$ to the right if $j(P) = i(P')$, $j(Q) = i(Q')$. Then $\{PP', QQ'\}$ is a twisted pair in $T \otimes T'$. For a twisted family \mathcal{F} in T , a *right-extending family* is an aligned family \mathcal{F}' in T' , for which there exists a bijection $e : \mathcal{F} \rightarrow \mathcal{F}'$, such that the pair $e(\{P, Q\}) \in \mathcal{F}'$ extends the pair $\{P, Q\}$ on the right. In this case, the family $\mathcal{F} \otimes_e \mathcal{F}' = \{\{PP', QQ'\} \mid \{P', Q'\} = e(\{P, Q\})\}$ is a twisted family in $T \otimes T'$. Extending to the left is defined similarly. Let $\mathcal{T} = (T_0, \dots, T_l, \dots, T_m)$ be a compatible sequence of tiles and \mathcal{F}_i a twisted family in T_i . If, for $i = l + 1, \dots, m$ (respectively, $i = l - 1, \dots, 0$), there exist aligned right- (left-) extending families \mathcal{F}_i of $\mathcal{F}_l \otimes \dots \otimes \mathcal{F}_{i-1}$ ($\mathcal{F}_{i+1} \otimes \dots \otimes \mathcal{F}_{l-1}$), then \mathcal{F}_l *propagates* to the right (left) in \mathcal{T} . \mathcal{F}_l *propagates* in cyclically-compatible \mathcal{T} if it propagates both to the left and to the right in every cut \mathcal{T}/i , $i = 0, \dots, m$, $i \neq l$.

A twisted family \mathcal{F} in a tile T *saturates* T if $\text{tr}(T) = |\mathcal{F}|$, i.e. there exists a tile drawing of T with $|\mathcal{F}|$ crossings. Clearly, all these crossings must be on the edges of pairs of paths in \mathcal{F} .

Corollary 4.10. *Let $\mathcal{T} = (T_0, \dots, T_l, \dots, T_m)$ be a cyclically-compatible sequence of tiles and \mathcal{F} a twisted family in T_l that propagates in \mathcal{T} . If $m \geq 4|\mathcal{F}| - 2$ and the tile T_i is a perfect planar tile for every $i = 0, \dots, m$, $i \neq l$, then $\text{cr}(\circ\mathcal{T}) \geq |\mathcal{F}|$. If \mathcal{F} saturates T_l , then the equality holds.*

Proof. As \mathcal{F} propagates in \mathcal{T} , Lemma 4.9 implies $\min_{i \neq l} \text{tr}(\otimes(\mathcal{T}/i)) \geq |\mathcal{F}|$. Theorem 4.5 establishes the claim. \square

4.3.2 Staircase strips

In this section, we study twisted staircase strips. Using these gadgets, we later construct new crossing-critical graphs with average degree close to three.

Let $\mathcal{P} = \{P_1, P_2, \dots, P_n\}$ be a sequence of traversing paths in a tile T with the property $\lambda(P_i) \leq \lambda(P_j)$ and $\rho(P_i) \geq \rho(P_j)$ for $i < j$. Assume that they are pairwise disjoint, except for the pairs P_1, P_2 and P_{n-1}, P_n which may share vertices, but not edges. For $u \in V(P_1) \cap V(P_2)$ and $v \in V(P_{n-1}) \cap V(P_n)$, we say that u is *left* of v if there exist internally disjoint paths Q_u and Q_v from u to v such that (cf. Figure 4.1):

- (s.i) there exist vertices $u_1, u'_1, \dots, u_n, u'_n$ that appear in this order on Q_u ,
- (s.ii) there exist vertices $v_1, v'_1, \dots, v_n, v'_n$ that appear in this order on Q_v ,
- (s.iii) $u = u_1 = u'_1 = u_2 = v_1$ and $v = u'_n = v'_{n-1} = v_n = v'_n$,

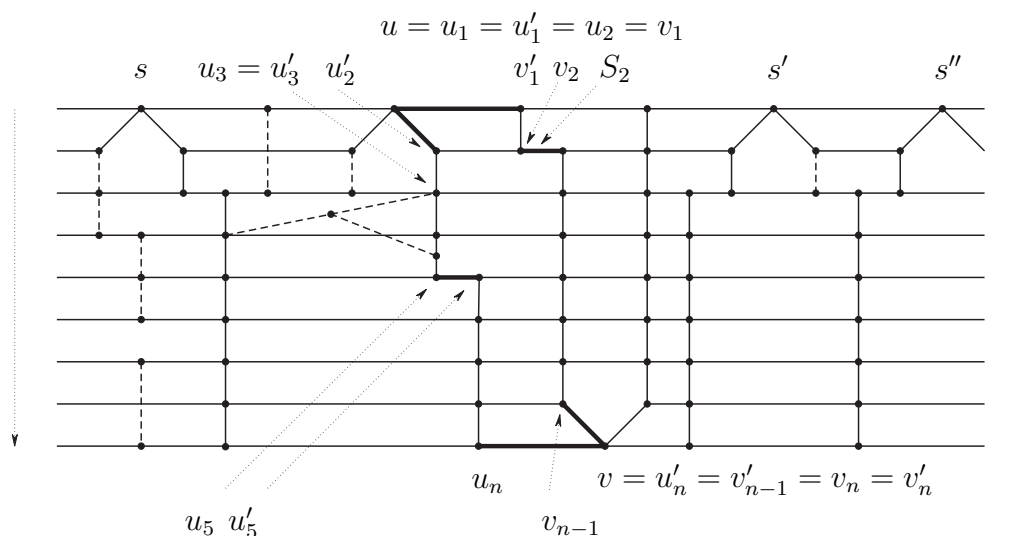

Figure 4.1: A general staircase strip in a tile. Leftmost and rightmost arrows indicate the ordering of the wall vertices. Dashed edges are part of the tile but not of the staircase strip.

- (s.iv) $v'_1, v_2, v'_2, u'_2 \notin P_1 \cap P_2$ and $v_{n-1}, u_{n-1}, u'_{n-1}, u_n \notin P_{n-1} \cap P_n$,
- (s.v) for $i = 1, \dots, n$, $R_i := u_i P_i u'_i \subseteq P_i \cap Q_u$, with equality for $i \neq n-1$,
- (s.vi) for $i = 1, \dots, n$, $S_i := v_i P_i v'_i \subseteq P_i \cap Q_v$, with equality for $i \neq 2$,
- (s.vii) $R_{n-1} = (P_{n-1} \cap Q_u) - R_n$ and $S_2 = (P_2 \cap Q_v) - S_1$,
- (s.viii) if $'u, u' \in P_1 \cap P_2$ are two vertices with $v'_1 \in 'u P_1 u'$, then $v_2 \in 'u P_2 u'$,
- (s.ix) if $'v, v' \in P_{n-1} \cap P_n$ are two vertices with $u_n \in 'v P_n v'$, then $u'_{n-1} \in 'v P_{n-1} v'$, and
- (s.x) $\lambda(P_i)u_i u'_i v_i v'_i \rho(P_i)$ lie in this order on P_i for $i = 1, \dots, n$.

Similarly, we define when u is *right* of v . We say that \mathcal{P} forms a *twisted staircase strip* of width n in the tile T if the vertex u is either left or right of the vertex v whenever $u \in V(P_1) \cap V(P_2)$ and $v \in V(P_{n-1}) \cap V(P_n)$.

Vertex u in Figure 4.1 is left of v . The features establishing this fact are emphasized. The subpaths $u'_i Q_u u_{i+1}$ and $v'_i Q_v v_{i+1}$ are, for $i = 2, \dots, n-1$, internally disjoint from P_j by (s.v) and (s.vi), for any $j = 1, \dots, n$, and their length is at least one. They are represented by solid vertical edges in the figure. However, the length of R_i and S_i , $i = 1, \dots, n$, may be zero; the thick edges in

the figure emphasize the instances when their length is positive. Solid edges in Figure 4.1 are part of a twisted staircase strip, dashed edges are not. Note that the vertices u and s are left of v and that the vertices s' and s'' are right of v .

Theorem 4.11. *Let T be a tile and assume that $\mathcal{P} = \{P_1, P_2, \dots, P_n\}$ forms a twisted staircase strip of width n in T . Then, $\text{tcr}(T) \geq \binom{n}{2} - 1$.*

Proof. If a wall vertex v in a tile T has degree d , then the tile crossing number of T is not changed if d new neighbors v_1, \dots, v_d of degree one are attached to v and v is in its wall replaced by v_1, \dots, v_d . Thus, we may assume that all paths in \mathcal{P} have distinct startvertices in λ and distinct endvertices in ρ .

Let D be any optimal tile drawing of T . By Lemma 4.9 there are at least $\binom{n}{2} - 2$ crossings in D , since the set $\mathcal{F} = \{\{P_i, P_j\} \mid 1 \leq i < j \leq n\} \setminus \{\{P_1, P_2\}, \{P_{n-1}, P_n\}\}$ is a twisted family in T . For $\{P_i, P_j\} \in \mathcal{F}$, let P_i cross P_j at $x_{i,j}$. In what follows, we contradict the assumption

$$x_{i,j} \text{ are all the crossings of } D. \quad (4.2)$$

For $i = 1, \dots, n$, let P_i be oriented from $\lambda(P_i)$ to $\rho(P_i)$. The assumption (4.2) implies that the induced drawing of every P_i is a simple curve. This curve splits the unit square $\Delta = I \times I$ containing D into two disjoint open disks, the lower disk Δ_i^- bordering $[0, 1] \times \{0\}$ and the upper disk Δ_i^+ bordering $[0, 1] \times \{1\}$.

Claim 1: *At $x_{i,j}$, the path P_j crosses from Δ_i^- into Δ_i^+ and the path P_i crosses from Δ_j^+ into Δ_j^- .* This follows from $i < j$ and the orientation of paths P_i and P_j .

As $\lambda(P_2) \in \Delta_1^-$ and $\rho(P_2) \in \Delta_1^+$, there is a vertex $u \in V(P_1) \cap V(P_2)$ where P_2 crosses P_1 from Δ_1^- to Δ_1^+ . Also, there is a vertex $v \in V(P_{n-1}) \cap V(P_n)$, such that P_{n-1} crosses from Δ_n^+ into Δ_n^- at v . Then Claim 1 holds for $x_{1,2} = u$ and $x_{n-1,n} = v$.

By symmetry, we may assume that u is left of v in T . Let Q_u and Q_v be the corresponding paths in T . P_2 enters Δ_1^+ at u , and (4.2), (s.iii), (s.iv), and (s.v) imply $u'_2 \in \Delta_1^+$. Similarly, $v_{n-1} \in \Delta_n^+$ by (4.2), (s.iv), (s.iii), and (s.vi).

Claim 2: *If any point y of $w'_i Q_w$ lies in Δ_i^- for $w \in \{u, v\}$ and $i \in \{1, \dots, n\}$, $w_i \neq u_{n-1}$, then the path Q_w must at w'_i enter Δ_i^- .* If $w \neq u$ or $i \neq n - 1$, the segment $w'_i Q_w y$ does not cross from Δ_i^+ to Δ_i^- due to Claim 1, thus it must lie in Δ_i^- .

Claim 3: *If there is a point y of $Q_w w_i$ in Δ_i^- for $w \in \{u, v\}$ and $i \in \{1, \dots, n\}$, $w_i \neq v_2$, then Q_w must at w_i leave Δ_i^- .* Otherwise, the segment $y Q_w w_i$ would contradict Claim 1 at x_{ji} for some $j < i$.

Claim 4: For $3 \leq i \leq n$, neither of u_i, v_i lies in Δ_1^- . Assume some $u_i \in \Delta_1^-$. As $u'_2 \in \Delta_1^+$, the path Q_u would contradict Claim 1 at $x_{1,j}$ for some j , $1 < j < i$. Assume $v_i \in \Delta_1^-$. Due to the orientation of P_i , (4.2), and (s.x), $u_i \in \Delta_1^-$, a contradiction.

Claim 5: For $1 \leq i \leq n-2$, neither of u'_i, v'_i lies in Δ_n^- . Assume $v'_i \in \Delta_n^-$. As $v_{n-1} \in \Delta_n^+$, the path Q_v would contradict Claim 1 at $x_{j,n}$ for some j , $i < j < n$. To complete the proof, observe that if $u'_i \in \Delta_n^-$, then $v'_i \in \Delta_n^-$ by (4.2) and (s.x).

In what follows, we prove that the subdrawing of D induced by $Q_u \cup Q_v \cup (\bigcup_i P_i)$ contains a new crossing, distinct from $x_{i,j}$, which contradicts (4.2). We first simplify the subdrawing and obtain a drawing D' in which for every i, j , $1 \leq i < j \leq n$, the paths P_i and P_j share precisely one point. We use the following steps:

- All vertices of $P_1 \cap P_2$, $P_{n-1} \cap P_n$ at which the two paths do not cross are split.
- As D is a tile drawing, there is an even number of crossing vertices in $V(P_1) \cap V(P_2)$ preceding u on P_1 . For a consecutive pair x, y of such vertices, the paths P_1 and P_2 are uncrossed by rerouting xP_1y along xP_2y and vice versa. The vertices x and y are split afterwards. The segments of P_{n-1} and P_n following v are uncrossed in a similar manner. By (s.i), (s.ii), (s.iii), and (s.x), the paths Q_u and Q_v are not affected.
- For any pair of vertices of $S_1 \cap P_2 - \{u\}$, the paths P_1 and P_2 are uncrossed in the same way. Due to (s.v), the vertex u'_2 is not on any of the two affected segments. Due to (s.iv), (s.vi) and (s.viii), neither of the segments can contain v'_1, v_2 or v'_2 . Thus, $u'_2, v_2, v'_2 \in P_2$ and $v'_1 \in P_1$ after the uncrossing. As all the pairs can be uncrossed, we may assume there is at most one crossing vertex in $S_1 \cap P_2$ distinct from u . But existence of such vertex implies by (s.viii) that $v_2 \in \Delta_1^-$, further implying by (s.vi) and (s.vii) that $v'_2 \in \Delta_1^-$. By (4.2), the segment $v'_2Q_vv_3$ does not cross P_1 , thus v_3 lies in Δ_1^- , contradicting Claim 4.
- As in the previous step, the paths P_{n-1} and P_n are uncrossed at any pair of vertices of $R_n \cap P_{n-1}$. Existence of a single remaining crossing vertex in $R_n \cap P_{n-1}$ would by (s.iv), (s.v), (s.vii), and (s.ix) imply $u'_{n-2} \in \Delta_n^-$, violating Claim 5.
- As D' is a tile drawing, there is an even number of crossing vertices in $v'_1P_1 \cap P_2$. By (s.viii) and (s.x), uncrossing the paths P_1, P_2 as before does not affect Q_v . Similarly, uncrossing the paths P_{n-1} and P_nu_n does not affect Q_u due to (s.ix) and (s.x).

All crossings in thus obtained drawing D' are also crossings of D , but some crossings of P_1 with P_i may have become crossings of P_2 and P_i and vice versa. The same applies to the pair (P_{n-1}, P_n) . We replace the labels $x_{i,j}$ accordingly. Until the end of the proof, we are concerned with the drawing D' only. In the new drawing, Claim 2 holds for $w_i = u_{n-1}$, Claim 3 for $w_i = v_2$, Claim 4 for $i = 2$, and Claim 5 for $i = n - 1$.

Claim 6: For $1 \leq i < j \leq n$, the subpath R_i of Q_u does not cross the subpath S_j of Q_v at $x_{i,j}$. Suppose it does and take the maximal such i . By Claim 1 and (s.x), u_j and v_j lie in Δ_i^- . Claim 2 implies that Q_u and Q_v enter Δ_i^- at u'_i and v'_i . Similarly, u'_i and v'_i lie in Δ_j^- and Claim 3 implies that Q_u and Q_v leave Δ_j^- at u_j, v_j . Thus, the segments $u'_i Q_u u_j$ and $v'_i Q_v v_j$ lie in the intersection $\Delta' = \Delta_i^- \cap \Delta_j^-$. Δ' is a disk as P_i and P_j do not self-cross and cross each other only once. The vertices u'_i, v'_i, u_j, v_j lie in this order on the boundary of Δ' , so the segments must intersect in Δ' . This contradicts either the assumption (4.2) or the maximality of i . Claim 6 follows.

Let γ^u denote the simplified path $P_1 u Q_u v P_{n-1}$: whenever this path self-crosses, the circuit is shortcut. Let γ_1^u, γ_2^u , and γ_3^u be the (possibly empty) segments of γ^u corresponding to P_1, Q_u , and P_{n-1} . Similarly, let γ^v denote the simplified path $P_2 u Q_v v P_n$ with the segments γ_1^v, γ_2^v , and γ_3^v . Using the induced orientation of γ^u and γ^v , we define disks $\Delta_u^+, \Delta_u^-, \Delta_v^+$, and Δ_v^- to be the respective lower and upper disks. The endvertices of γ^u and γ^v interlace in the boundary of $[0, 1] \times [0, 1]$, thus these paths must cross at some crossing $z = z_{i,j}$ of segments γ_i^u and γ_j^v . We contradict the assumption that $z = x_{i,j}$ for some i, j . Due to the definition of γ^u and γ^v , there are nine possibilities for z :

- (1) $z = z_{1,1} = u$ is a touching of γ^u and γ^v .
- (2) $z = z_{1,2} = x_{1,i}$ for some $i > 2$. Thus, $v_i \in \Delta_1^-$ contradicts Claim 4.
- (3) $z = z_{1,3} = x_{1,n}$ implies $u_n \in \Delta_1^-$.
- (4) $z = z_{2,1} = x_{i,2}$ for some $i > 2$, then $u_i \in \Delta_1^-$.
- (5) $z = z_{2,2} = x_{i,j}$ is a crossing of S_i and R_j . Claim 6 implies that $1 \leq i < j \leq n$. Choose smallest such i and then smallest j . Q_v starts in Δ_u^- and since z is the first crossing of Q_v with γ^u (or one of the other eight cases would apply), Q_v leaves Δ_u^- and enters Δ_u^+ at z . As the orientation of γ^u is aligned with the orientation of R_j , S_i leaves Δ_j^- , which contradicts Claim 1.
- (6) $z = z_{2,3} = x_{i,n}$ for some $i < n$, then $u'_i \in \Delta_n^-$, which contradicts Claim 5.
- (7) $z = z_{3,1} = x_{2,n-1}$ implies $v'_2 \in \Delta_n^-$.

- (8) $z = z_{3,2} = x_{i,n-1}$ is the crossing of P_{n-1} and S_i , then $v'_i \in \Delta_n^-$.
- (9) $z = z_{3,3} = v$ is a touching of γ^u and γ^v .

Thus, γ^u and γ^v must cross at a new crossing and the statement of the theorem follows. \square

4.3.3 Cloned vertices

Cloned vertices were used as gadgets in the construction of 3-connected k -crossing-critical graphs by Kochol [72].

A *clone* of a vertex v in a graph G is a vertex v' , such that $N_G^*(v) \setminus \{v\} = N_G^*(v') \setminus \{v'\}$, i.e. v' has the same multiplicity neighborhood as v (modulo v, v'). A pair of clones (v, v') forms a *clone gadget* of *degree* d in a graph G if no multiple edges are incident with these two vertices, $|N_G(v) \setminus \{v'\}| = d$ and there exists a bundle B of v in the graph $G - v'$. For a vertex v and its clone v' , let $E(v, v')$ denote the set of edges emanating from v not incident with v' . We define $E(v', v)$ similarly. Two clone gadgets $(v_1, v'_1), (v_2, v'_2)$ with respective bundles B_1, B_2 are *coherent* if the sets $\{E(v_1, v'_1), E(v'_1, v_1), \check{E}(B_1)\}$ and $\{E(v_2, v'_2), E(v'_2, v_2), \check{E}(B_2)\}$ are coherent.

Lemma 4.12. *Let G be a graph, (v, v') a clone gadget of degree d in G , B a bundle of (v, v') , and D a drawing of G . There are at least $\text{cr}(K_{3,d})$ crossings in D involving two edges from distinct sets among $E(v, v')$, $E(v', v)$, $\check{E}(B)$.*

Proof. The argument uses the splitting of the bundle. Let \bar{G} be the subgraph of G , induced by the edges of $E(v, v') \cup E(v', v) \cup \check{E}(B)$, and let \bar{D} be its D -induced subdrawing. By splitting B in \bar{D} (cf. Lemma 3.3), we obtain a drawing D' of a subdivision of $K_{3,d}$. Since all the crossings of D' are the crossings of D , the claim follows. \square

Proposition 4.13. *Let $\{(v_1, v'_1), \dots, (v_t, v'_t)\}$ be pairwise coherent clone gadgets in a graph G . Then, $\text{cr}(G) \geq \sum_{i=1}^t \text{cr}(K_{3,d_i})$, where d_i is the degree of the gadget (v_i, v'_i) .*

Proof. For some $j \in \{1, \dots, t\}$, let (v_j, v'_j) be a clone gadget of degree d_j and B_j its bundle. By Lemma 4.12, there are at least $\text{cr}(K_{3,d_j})$ crossings with the property that the two crossed edges come from two distinct sets among $\check{E}(B_j)$, $E(v_j, v'_j)$, and $E(v'_j, v_j)$. As the clone gadgets (v_i, v'_i) , $1 \leq i \leq t$, are pairwise coherent, these crossings can be exclusively attributed to the gadget (v_j, v'_j) . The claim follows. \square

By generalizing bundles in graphs to bundles in tiles using suspensions of tiles, one can obtain more general clone gadgets that use the structure of tiles. We can also extend clone gadgets to graphs $K_{c,d}$ for $c > 3$.

4.3.4 Wheel gadgets

Cloned vertices use the minimal nonplanar graph $K_{3,3}$ and its generalizations as the underlying structure to count crossings. In this section, we introduce the wheel gadgets that use the other minimal nonplanar graph, K_5 . To our knowledge, wheel gadgets were not applied to compute tile crossing numbers. We use them in Chapter 6 to study the crossing numbers of Cartesian products of wheels and trees.

Let a vertex v have a bundle B of degree d with the sink u in a graph G . If there exists a cycle C in G , such that C intersects each path of B at most in one internal vertex of B , then the triple (v, B, C) forms a *wheel* in G . Cycle C is the *rim* of the wheel, vertex v is the *inner hub*, and u is the *outer hub*. An *inner spoke* is a subpath from v to C of some path in B , an *outer spoke* is a subpath from u to C of some path in B , and an *axis* is a path in B that has no vertices in common with C . A *wheel gadget* in G is a wheel in G that has at least one axis and at least three inner spokes that meet C in distinct vertices.

Lemma 4.14. *Let G be a simple graph, $W = (v, B, C)$ a wheel gadget in G , and D a drawing of G . Then, D contains (i) a crossing of some axis of W with the rim, (ii) a crossing of some spoke of W with the rim, or (iii) a crossing of an inner spoke with an outer spoke of W .*

Proof. Let $P_1, P_2, P_3 \in B$ be three paths containing three inner spokes of W and $Q \in B$ an axis of W . Let \bar{D} be the subdrawing of D induced by $C \cup Q \cup \bigcup_{i=1}^3 P_i$ and let D' be the drawing obtained from \bar{D} by splitting the sub-bundle $B' = \{P_1, P_2, P_3\}$. The splitting preserves the crossings of its paths that occurred in the original drawing. Since the vertices of $C \cap B'$ lie on distinct paths of B' , they are not split.

D' is a drawing of a subdivision of K_5 , in which C corresponds to a triangle. We partition the edges of D' into four sets: the edges of the rim, the inner spokes, the outer spokes, and the axis. Any two curves in D' that represent edges from the same of these sets, share an endvertex of K_5 and may be uncrossed in D' . The crossings between an axis and a spoke can also be uncrossed. Thus, some crossing of D' (originating in D) must be between edges from two different sets and not a crossing of an axis and a spoke, implying one of (i), (ii), or (iii). \square

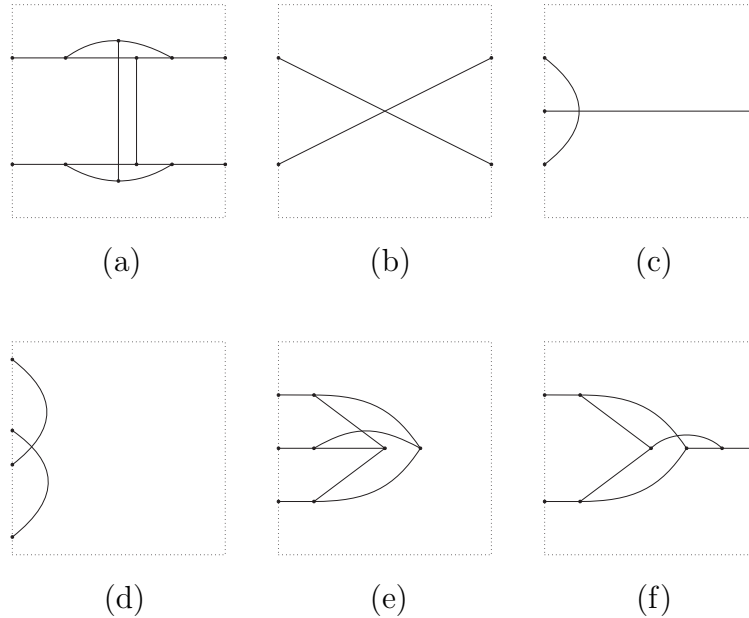

Figure 4.2: (a) Bridge. (b) Twisted pair. (c) Split pair. (d) Intertwined pair. (e) One-sided tripod. (f) Two-sided tripod.

We can generalize wheel gadgets from graphs to tiles using generalized bundles similarly as clone gadgets.

4.3.5 Other gadgets

In Sections 4.3.1–4.3.4, we have described several gadgets that were used in design of *twisted* crossing-critical graphs. These are graphs that are obtained from a twist of a cyclically-compatible sequence of perfect planar tiles. The crossed k -fences, a family of k -crossing-critical graphs designed by Hliněný in [53], do not fit this pattern. However, the crossed k -fences can be described in terms of tiles and a possible gadget that establishes the lower bound on the tile crossing number is the *bridge gadget* presented in Figure 4.2 (a). This gadget has at least two crossings on its edges. It is not clear whether bridges in combination with twisted pairs suffice to establish the crossing numbers of crossed k -fences; perhaps we need a more involved gadget resembling staircase strips.

Minimal gadgets in a tile T that force $\text{tcr}(T) \geq 1$ have been classified by Mohar [83]. They are presented in Figure 4.2. Besides twisted pairs from Section 4.3.1 they include *split pairs*, *intertwined pairs*, and one- or two-sided *tripods*. All of these come in their left or right variants. In addition, paper [83]

classifies gadgets forcing $\text{tcr}(T) \geq 1$ in cylinder drawings of tiles (where vertices from the same wall of T are restricted to be drawn in the respective sequence in one component of the boundary of the cylinder).

Note that some edges incident with wall vertices of bridges and tripods may be contracted. The new structure would still be a gadget of the same tile crossing number. Also, tripods are a generalized clone-gadgets, with the bundle of the two clones contained in the suspension T^* and not in T .

The zip product could be extended to tiles using generalized bundles. Applying the resulting operation to a vertex v of a tile T and a vertex u of a graph G , which both have two (generalized) coherent bundles, would result in a new tile $T' \in T_v \odot_u G$, whose tile crossing number would be at least the sum of $\text{tcr}(T)$ and $\text{cr}(G)$. Thus, any graph with positive crossing number and semiactive vertices can be used as a gadget.

Chapter 5

Constructions

In this chapter, we apply results of Chapters 3 and 4 and construct four new families of critical graphs. Staircase strips are applied in design of a three-parameter family of crossing-critical graphs with average degree arbitrarily close to three. Using twisted pairs, we define two-parameter crossing-critical graphs with average degree arbitrarily close to six. An iterated zip product of graphs $K_{d,d'}$ yields crossing-critical graphs with arbitrarily many vertices of degree d . We combine these graphs using the zip product and fine-tune their parameters to obtain crossing-critical graphs with prescribed average degree and crossing number.

5.1 Graphs with average degree close to three

The reader shall have no difficulty rigorously describing the tile S_n , $n \geq 3$, an example of which is for $n = 7$ presented in Figure 5.1 (a). A *staircase tile* of width $n \geq 3$ is a tile obtained from S_n by contracting some (possibly zero) thick edges of S_n . Such a tile is a perfect planar tile. A *staircase sequence* of width n is a sequence of tiles of odd length in which staircase tiles of width n alternate with inverted staircase tiles of width n . Any staircase sequence is a cyclically-compatible sequence of tiles.

Proposition 5.1. *Let \mathcal{T} be a staircase sequence of width n and odd length $m \geq 4\binom{n}{2} - 5$. The graph $G = \circ(\mathcal{T}^\dagger)$ is a crossing-critical graph with $\text{cr}(G) = \binom{n}{2} - 1$.*

Proof. A generalization of the drawing in Figure 5.1 demonstrates that $\text{tcr}(S_n) = \binom{n}{2} - 1$. As m is odd, the cut \mathcal{T}^\dagger/i contains a twisted staircase strip of width n for any $i = 0, \dots, m-1$, and Theorem 4.11 implies $\text{tcr}(\mathcal{T}^\dagger/i) \geq \binom{n}{2} - 1$.

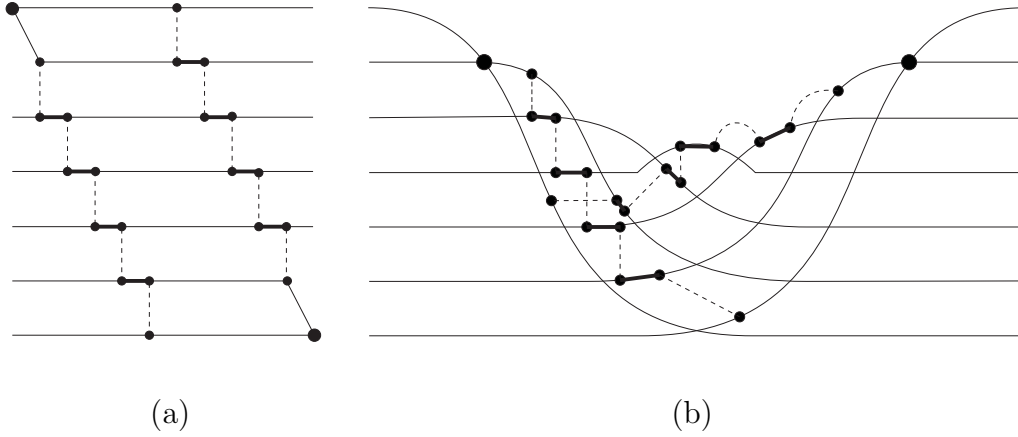

Figure 5.1: (a) The tile S_7 . (b) A tile drawing of S_7 with 20 crossings.

Planarity of tiles S_n and Lemma 4.1 establish equality and Corollary 4.6 implies $\text{cr}(G) = \binom{n}{2} - 1$.

After removing any edge from S_n , we can decrease the number of crossings in the drawing in Figure 5.1 (b). Thus, S_n is a $(\binom{n}{2} - 1)$ -degenerate tile and \mathcal{T} is a $(\binom{n}{2} - 1)$ -critical sequence; the criticality of G follows by Corollary 4.7. \square

Let S'_n be the inverted tile S_n . For odd $m \geq 1$, let $\mathcal{S}_{n,m}$ be the staircase sequence $(S_n, S'_n, S_n, S'_n, \dots, S_n)$ of odd length m . Let $\mathcal{S}(n, m, c)$ denote the set of graphs, obtained from $\circ(\mathcal{S}_{n,m}^\dagger)$ by contracting c thick edges in the tiles of $\mathcal{S}_{n,m}$. The graphs in $\mathcal{S}(n, m, c)$ are $(\binom{n}{2} - 1)$ -crossing-critical for $m \geq 4\binom{n}{2} - 5$ and $0 \leq c \leq 2m(n - 2)$, by Proposition 5.1. They almost settle Question 2.14 for rational $r \in (3, 4)$:

Proposition 5.2. *Let $r = 3 + \frac{a}{b}$ with $1 \leq a < b$. If $a + b$ is odd, then, for $n \geq \max\left(\frac{5b-a}{2(b-a)}, \frac{7a+b}{4a}, 4\right)$, $m(t) = (2t+1)(a+b)$, and $c(t) = (2t+1)((4n-7)a - b)$, the family $\mathcal{Q}(a, b, n) = \bigcup_{t=n^2}^\infty \mathcal{S}(n, m(t), c(t))$ contains $(\binom{n}{2} - 1)$ -crossing-critical graphs with average degree r .*

Proof. For $G \in \mathcal{Q}(a, b, n)$, let t be such that $G \in \mathcal{S}(n, m(t), c(t))$. As $m(t) \geq 4\binom{n}{2}$ and $m(t)$ is odd, Proposition 5.1 implies that G is an $(\binom{n}{2} - 1)$ -crossing-critical graph. By construction, G has $n_3 = 4(2m(t) - 1)(n - 2) - 2c(t)$ vertices of degree three and $n_4 = m(t) + c(t)$ vertices of degree four. A short calculation establishes that the average degree of G is r . Details can be found in [19]. \square

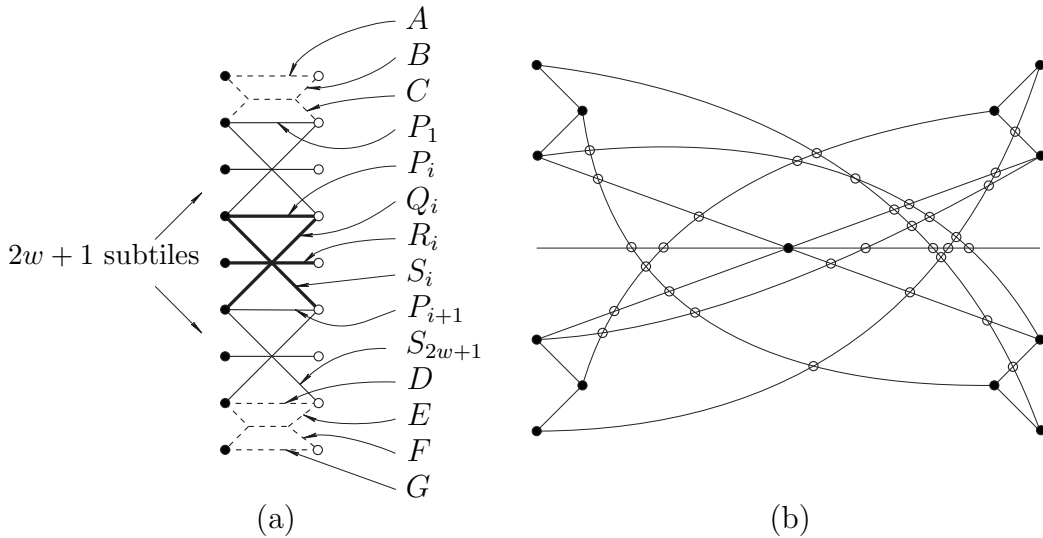

Figure 5.2: (a) The tile H_w , $w = 1$. (b) An optimal tile drawing of H_0 .

Demanding the average degree of $\circ\mathcal{S}(m, n, c)$ to be $r = 3 + \frac{a}{b}$, $1 \leq a < b$, $a + b$ even, forces $m(t)$ to be an even number. The pattern in the staircase sequences is broken at the join of the first and the last tile and the resulting graphs are no longer critical. For such r , a more involved construction is needed.

5.2 Graphs with average degree close to six

Let H_w be a tile, which is for $w = 1$ presented in Figure 5.2 (a). It is constructed by joining two subtiles, denoted by dashed edges, with a sequence of $2w + 1$ subtiles, of which one is drawn with thick edges. The left (right) wall vertices of H_w are colored black (white). H_w is a perfect planar tile. Let $\mathcal{H}(w, s) = (H_w, \dots, H_w)$ be a sequence of tiles of length s and let $H(w, s) = \circ(\mathcal{H}(w, s)^\dagger)$ be the cyclization of its twist.

Proposition 5.3. *The graph $H(w, s)$ is a crossing-critical graph with crossing number $k = 32w^2 + 56w + 31$ whenever $s \geq 4k - 1$.*

Proof. We define the following sets for $1 \leq i, p \leq 2w + 1$, $p \neq 2w + 1$ and note their sizes:

$$\begin{aligned}
\mathcal{A}_w &= \{\{A, P_i\}, \{A, Q_i\}, \{A, R_i\}, \{A, S_i\} \mid 1 \leq i \leq 2w+1\} \\
&\cup \{\{A, C\}, \{A, D\}, \{A, E\}, \{A, G\}\}, \\
|\mathcal{A}_w| &= 8w+8, \\
\mathcal{B}_w &= \{\{B, P_i\}, \{B, Q_i\}, \{B, R_i\}, \{B, S_i\} \mid 1 \leq i \leq 2w+1\} \\
&\cup \{\{B, D\}, \{B, E\}, \{B, G\}\}, \\
|\mathcal{B}_w| &= 8w+7, \\
\mathcal{D}_w &= \{\{D, P_i\}, \{D, Q_i\}, \{D, R_i\}, \{D, S_j\} \mid 1 \leq i, j \leq 2w+1, j \neq 2w+1\} \\
&\cup \{\{D, F\}, \{D, G\}\}, \\
|\mathcal{D}_w| &= 8w+5, \\
\mathcal{E}_w &= \{\{E, P_i\}, \{E, Q_i\}, \{E, R_i\}, \{E, S_j\} \mid 1 \leq i, j \leq 2w+1, j \neq 2w+1\} \\
&\cup \{\{E, G\}\}, \\
|\mathcal{E}_w| &= 8w+4, \\
\mathcal{F}_w &= \{\{F, S_{2w+1}\}\}, \\
\mathcal{G}_w &= \{\{G, P_i\}, \{G, Q_i\}, \{G, R_i\}, \{G, S_i\} \mid 1 \leq i \leq 2w+1\}, \\
|\mathcal{G}_w| &= 8w+4, \\
\mathcal{P}_{w,i} &= \{\{P_i, P_j\}, \{P_i, Q_j\}, \{P_i, R_l\}, \{P_i, S_l\} \mid i \leq j, l \leq 2w+1, j \neq i\}, \\
|\mathcal{P}_{w,i}| &= 8w+6-4i, \\
\mathcal{Q}_{w,i} &= \{\{Q_i, P_j\}, \{Q_i, Q_j\}, \{Q_i, R_j\}, \{Q_i, S_j\} \mid i < j \leq 2w+1\}, \\
|\mathcal{Q}_{w,i}| &= 8w+4-4i, \\
\mathcal{R}_{w,i} &= \{\{R_i, P_j\}, \{R_i, Q_j\}, \{R_i, R_j\}, \{R_i, S_j\} \mid i < j \leq 2w+1\}, \\
|\mathcal{R}_{w,i}| &= 8w+4-4i, \\
\mathcal{S}_{w,i} &= \{\{S_i, P_j\}, \{S_i, Q_j\}, \{S_i, R_l\}, \{S_i, S_l\} \mid i < j, l \leq 2w+1, l \neq i+1\}, \\
|\mathcal{S}_{w,p}| &= 8w+2-4p.
\end{aligned}$$

The family $\mathcal{H}_w = \mathcal{A}_w \cup \mathcal{B}_w \cup \mathcal{D}_w \cup \mathcal{E}_w \cup \mathcal{F}_w \cup \mathcal{G}_w \cup \bigcup_{i=1}^{2w+1} (\mathcal{P}_{w,i} \cup \mathcal{Q}_{w,i} \cup \mathcal{R}_{w,i} \cup \mathcal{S}_{w,i})$ is an aligned family in H_w . The sets in the union are pairwise disjoint, thus $|H_w|$ equals the sum of their sizes:

$$\begin{aligned}
|H_w| &= 5 \cdot 8w + 29 + \sum_{i=1}^{2w} (4(8w-4i) + 16) + 2 \\
&= 64w^2 + 72w + 31 - 16 \sum_{i=1}^{2w} i \\
&= 32w^2 + 56w + 31 \\
&= k.
\end{aligned}$$

The corresponding family \mathcal{H}'_w in H_w^\dagger is twisted and propagates in $\mathcal{H}(w, s)^\dagger$. Figure 5.2 (b) presents an optimal tile drawing of H_0 , its generalization to $w > 0$ demonstrates that \mathcal{H}'_w saturates H_w^\dagger . The crossing number of $H(w, s)$ is established by Corollary 4.10.

The number of crossings can be decreased after removing any edge from the drawing in Figure 5.2 (b). This also applies to the generalization of the drawing, thus H_w is a k -degenerate tile. The propagation of the twisted family \mathcal{F}' demonstrates $\text{tcr}(\otimes(\mathcal{H}(w, s)^\dagger/i)) \geq k$ for any $i \neq s$, thus $\mathcal{H}(w, s)^\dagger$ is a k -critical sequence and the criticality of $H(w, s)$ follows by Corollary 4.7. \square

5.3 Adapting graphs

For $d, d' \geq 3$, let $K_{d,d'}$ be a properly 2-colored complete bipartite graph: vertices of degree d are colored black and vertices of degree d' are colored white. For $p \geq 1$, let the family $\mathcal{R}(d, d', p)$ consist of graphs with 2-colored vertices, obtained as follows: $\mathcal{R}(d, d', 1) = \{K_{d,d'}\}$ and $\mathcal{R}(d, d', p) = \bigcup_{G \in \mathcal{R}(d, d', p-1)} G \circ_{v_1 \odot v_2} K_{d,d'}$, where v_1 (respectively, v_2) is a black vertex in G ($K_{d,d'}$). If $d = d' = 3$, we allow v_i to be any vertex. We preserve the colors of vertices in the zip product, thus the graphs in $\mathcal{R}(d, d', p)$ are not properly colored for $p \geq 2$.

Proposition 5.4. *Let $d, d' \geq 3$. Then every graph $G \in \mathcal{R}(d, d', p)$ is a simple 3-connected crossing-critical graph with $\text{cr}(G) = p \text{cr}(K_{d,d'})$.*

Proof. By induction on p and using Theorem 3.7 (iii), we show that all black vertices of G are active. Iterative application of Theorem 3.7 (i) and (ii) establishes the crossing number of G and its criticality. For $d = d' = 3$, the claim follows similarly by Theorem 3.8. \square

Jaeger proved the following result:

Theorem 5.5 ([56]). *Every 3-connected cubic graph with crossing number one has chromatic index three.*

We use the family $\mathcal{R}(3, 3, p)$ to show that a similar result cannot be obtained for any crossing number greater than one.

Proposition 5.6. *For $k \geq 2$, there exist simple cubic 3-connected crossing-critical graphs with crossing number k and with no 3-edge-coloring.*

Proof. Let P be the Petersen graph. It is cubic, 3-connected, and has no 3-edge-coloring. Its crossing number is two and it is crossing-critical, since it is edge-transitive. The claim thus holds for $k = 2$.

For $k \geq 3$, let $G \in \mathcal{R}(3, 3, k-2)$ be arbitrary and let G_k be a zip product of G and P . Since every vertex in P has two coherent bundles, Theorem 3.8 and Proposition 5.4 assert that G_k has crossing number k and is crossing-critical. It is 3-connected by Lemma 3.6 (ii).

Suppose G_k has a 3-edge-coloring c . We may assume the colors are nonzero elements of the group $\mathbb{Z}_2 \times \mathbb{Z}_2$. Since the colors around every vertex add up to zero, the coloring c represents a nonzero $\mathbb{Z}_2 \times \mathbb{Z}_2$ -flow on G_k . Thus, the sum of colors on any edge-cut of G_k is zero. In particular, the three edges that result from the zip product of G and P receive distinct colors. This implies existence of a 3-edge-coloring of P , a contradiction. \square

Graphs with the above properties can be constructed also as zip products of k copies of the Petersen graph. The resulting graph has crossing number $2k$. A zip product of such graph with crossing number k and any planar cubic graph has all the stated properties, except it is not crossing-critical. Thus, for every $k \geq 2$ there exists an infinite family of simple cubic 3-connected graphs with crossing number k and with no 3-edge-coloring.

5.4 Infinite families of crossing-critical graphs with prescribed average degree and crossing number

In this section we prove the main result of this thesis: we settle Question 2.14.

Theorem 5.7. *Let $r \in (3, 6)$ be a rational number and k an integer. There exists a convex continuous function $f : (3, 6) \rightarrow \mathbb{R}^+$ such that for $k \geq f(r)$ there exists an infinite family of simple 3-connected crossing-critical graphs with average degree r and crossing number k .*

Proof. We present a constructive proof for

$$f(r) = 240 + \frac{512}{(6-r)^2} + \frac{224}{6-r} + \frac{25}{16(r-3)^2} + \frac{40}{r-3}.$$

A sketch of the construction is as follows: The graphs are obtained as a zip product of crossing-critical graphs from the families \mathcal{S} and \mathcal{R} , and of the graphs H , defined in Sections 5.1–5.3. The graphs H allow average degree close to six and the graphs from \mathcal{S} allow average degree close to three. A disjoint union of two such graphs consisting of a proportional number of tiles would have a fixed average degree and crossing number. The zip product compromises the pattern needed for fixed average degree, for which we compensate with the

graphs from \mathcal{R} . Their role is also to fine-tune the desired crossing number of the resulting graph.

More precisely, let $\Gamma(n, m, c, w, s, p, q)$ be the family of graphs, constructed in the following way: first we combine graphs $G_1 \in \mathcal{S}(n, m, c)$ and $G_2 = H(w, s)$ in the family $\Gamma(n, m, c, w, s, 0, 0) = \bigcup_{G_1, G_2} \bigcup_{v_1, v_2} G_1 \circ_{v_1, v_2} G_2$. Further, we combine the graphs $G_1 \in \Gamma(n, m, c, w, s, 0, 0)$ and $G_2 \in \mathcal{R}(3, 3, p)$ in the family $\Gamma(n, m, c, w, s, p, 0) = \bigcup_{G_1, G_2} \bigcup_{v_1, v_2} G_1 \circ_{v_1, v_2} G_2$. Finally, we combine the graphs $G_1 \in \Gamma(n, m, c, w, s, p, 0)$ and $G_2 \in \mathcal{R}(3, 5, q)$ in the family $\Gamma(n, m, c, w, s, p, q) = \bigcup_{G_1, G_2} \bigcup_{v_1, v_2} G_1 \circ_{v_1, v_2} G_2$. In each case, $v_i \in V(G_i)$ is any vertex of degree three. Propositions 5.1, 5.3, and 5.4 imply that the graphs used in construction are crossing-critical graphs whenever the following conditions are satisfied:

$$n \geq 3, \quad (5.1)$$

$$m = 2m' + 1, \quad (5.2)$$

$$m' \geq 2 \binom{n}{2}, \quad (5.3)$$

$$c \geq 0, \quad (5.4)$$

$$c \leq 2m(n - 3), \quad (5.5)$$

$$w \geq 0, \quad (5.6)$$

$$s \geq 4(32w^2 + 56w + 31), \quad (5.7)$$

$$p \geq 1, \text{ and} \quad (5.8)$$

$$q \geq 1. \quad (5.9)$$

All vertices of degree three in these graphs are semiactive. Results in [65] establish $\text{cr}(K_{3,5}) = 4$, thus Theorem 3.8 implies that subject to (5.1)–(5.9) the graphs in $\Gamma(n, m, c, w, s, p, q)$ are crossing-critical with crossing number

$$k = \binom{n}{2} + 32w^2 + 56w + p + 4q + 30. \quad (5.10)$$

Their average degree is

$$\bar{d} = 6 - \frac{4(m'(6n - 11) + 3n + 3p + 3q + 4s - c - 7)}{2m'(4n - 7) + 4n + 4sw + 9s + 4p + 6q - c - 9}. \quad (5.11)$$

Using (5.10) we express p in terms of k and other parameters. We set s and m to be a linear function of a new parameter t , which will determine the size of the resulting graph. We substitute these values into (5.11). Using c we eliminate all the terms in the denominator that are independent of t . Parameter q plays the same role in the numerator. Then t cancels and we

set the coefficients of the linear functions to yield the desired average degree. Finally, parameters n , w , and the constant terms of the linear functions are selected to satisfy the constraints (5.1)–(5.9). A more detailed analysis might produce a smaller lower bound f , but one constant term was selected to be zero to simplify the computations.

More precisely, let $r = 3 + \frac{a}{b}$, $0 < a < 3b$, and $k \geq f(r)$. Perform the following integer divisions:

$$\begin{aligned} b &= b'a + b_r, \\ b' &= 4b'' + b'_r, \\ 4b &= \bar{b}(3b - a) + \bar{b}_r, \text{ and} \\ k - \frac{b''(b''+5)}{2} - 8\bar{b}(4\bar{b} + 7) &= k'(2b'' + 5) + k_r. \end{aligned}$$

For some integer t set

$$\begin{aligned} n &= b'' + 4, \\ m_t &= 2t(27b - 9a - 4\bar{b}_r) - 2k' + 3, \\ c &= 2k' - 12b'' - 6k_r - 33, \\ w &= \bar{b}, \\ s_t &= 2t((4b'' + 9)a - b), \\ p &= k - \left(\frac{b''(b''+23)}{2} + 8\bar{b}(4\bar{b} + 7) + 4k_r + 56 \right), \text{ and} \\ q &= 2b'' + k_r + 5. \end{aligned}$$

The family $\Gamma(a, b, k) = \bigcup_{t=k}^{\infty} \Gamma(n, m_t, c, w, s_t, p, q)$ is an infinite family of crossing-critical graphs with average degree r and crossing number k . Verification of the constraints (5.1)–(5.9) for any $r \in (3, 6)$ and $k \geq f(r)$ requires some tedious computation that is omitted here; an interested reader can find it in [19]. The function f is a sum of functions that are convex on $(3, 6)$ and thus itself convex. The graphs of $\Gamma(a, b, k)$ are 3-connected by Lemma 3.6 (ii). \square

The convexity of the function f in Theorem 5.7 implies $N_I = \max\{f(r_1), f(r_2)\}$ is a universal lower bound on k for rational numbers within any closed interval $I = [r_1, r_2] \subseteq (3, 6)$.

5.5 Structure of crossing-critical graphs

Oporowski has established that all large 2-crossing-critical graphs are obtained as cyclizations of long sequences, composed out of copies of a small number

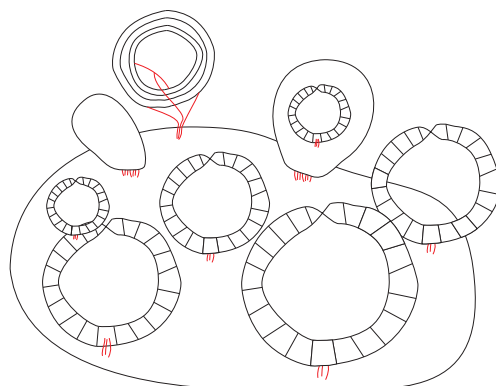

Figure 5.3: Structure of known large k -crossing-critical graphs.

of different tiles [87]. The construction of crossing-critical graphs using zip product demonstrates that no such classification of tiles can exist for $k \geq 4$: by a generalized zip product of a graph and a tile, as proposed in Section 4.3.5, one can obtain an infinite sequence of k -degenerate tiles, all having the same tile crossing number. These tiles in combination with corresponding perfect planar tiles yield k -crossing-critical graphs.

For k large enough, one can obtain k -crossing-critical graphs from an arbitrary (not necessarily critical) graph that has a vertex cover consisting of semiactive vertices of degree three, cf. Theorem 3.9. Figure 5.3 sketches the described structure.

Regarding the degrees of vertices in k -crossing-critical graphs, the following questions remain open:

Question 5.8 ([105]). *Do there exist an integer $k > 0$ and an infinite family of (simple) 5-regular 3-connected k -crossing-critical graphs?*

Question 5.9. *Do there exist an integer $k > 0$ and an infinite family of (simple) 3-connected k -crossing-critical graphs of average degree six?*

Arguments of [105] used to establish that for $k > 0$ there exist only finitely many k -crossing-critical graphs with minimum degree six extend to graphs with a bounded number of vertices of degree different than six. Thus, we may assume that a family positively answering Question 5.9 would contain graphs with arbitrarily many vertices of degree larger than six. But only vertices of degrees three, four, or six appear arbitrarily often in the graphs of the known infinite families of k -crossing-critical graphs. We thus propose the following question, an answer to which would be a step in answering Questions 5.8 and 5.9.

Question 5.10. *Does there exist an integer $k > 0$, such that for every integer n there exists a 3-connected k -crossing-critical graph G_n with more than n vertices of degree distinct from three, four and six?*

We can obtain arbitrarily large crossing-critical graphs with arbitrarily many vertices of degree d , for any d , by applying the zip product to graphs $K_{3,d}$, $K_{d,d}$, and the graphs from the known infinite families. However, the crossing numbers of these graphs grow with the number of such vertices.

Chapter 6

The crossing numbers of Cartesian products

In this chapter, we apply the zip product to establish lower and upper bounds on the crossing numbers of Cartesian products of some graphs with trees. We obtain several new exact results.

6.1 General graphs

Let $G^{(i)}$ be the *suspension* of order i of a graph G , i.e. the complete join of G and an empty graph on i vertices $\{v_1, \dots, v_i\}$, called the *apices* of $G^{(i)}$. For a multiset $L \subseteq V(G_2)$, we denote with $G_1 \square_L G_2$ the *capped Cartesian product* of graphs G_1 and G_2 , i.e. the graph obtained by adding a distinct vertex v' to $G_1 \square G_2$ for each copy of a vertex $v \in L$ and joining v' to all vertices of $G_1 \square \{v\}$. We call v' a *cap* of v . When L contains precisely all vertices of degree one in G_2 , we use $G_1 \widehat{\square} G_2$ in place of $G_1 \square_L G_2$. For $v \in V(H)$, let $\chi_L(v)$ denote the multiplicity of v in L and let $\ell(v) := \deg_{G_2}(v) + \chi_L(v)$. An edge $uv \in E(G_2)$ is *unbalanced* if $\ell(u) \neq \ell(v)$. Let $\beta(G_2)$ be the number of unbalanced edges of G_2 .

Theorem 6.1. *Let T be a tree, $L \subseteq V(T)$ a multiset with $\ell(v) \geq 2$ for every $v \in V(T)$, and G a graph of order n with a dominating vertex. Define*

$$B = \sum_{v \in V(T)} \text{cr}(G^{\ell(v)}).$$

Then, $B \leq \text{cr}(G \square_L T) \leq B + \beta(T) \binom{n-1}{2}$ and $\text{cr}(G \square_L T) = B$ whenever the automorphism group of G acts as a symmetric group on the neighbors of the dominating vertex of G .

Proof. Let $\mathcal{L} = \ell(V(T))$ be the set of different values of $\ell(v)$, $v \in V(T)$. For $l \in \mathcal{L}$, let $D^{(l)}$ be a fixed optimal drawing of $G^{(l)}$. Let v_1, \dots, v_m be some depth-first search ordering of vertices of T , set $l_i = \ell(v_i)$, and let $e_i = v_i u_i$ be the edge connecting v_i with $T[\{v_1, \dots, v_{i-1}\}]$.

Using this setup we construct $G \square_L T$ as a sequence of zip products of suspensions of G . Let $G_1 = G^{(l_1)}$ and for $i = 2, \dots, m$ define $G_i = G^{(l_i)} \odot_{\iota_i} G_{i-1}$, where ι_i maps a vertex of the G subgraph of $G^{(l_i)}$ to its counterpart in the neighborhood of some cap u' of u_i , $u' \in V(G_{i-1})$. The graph G_m is isomorphic to $G \square_L T$. Since G has a dominating vertex, the apices in the suspensions have two coherent bundles. Iterative application of Theorem 3.4 implies $\text{cr}(G \square_L T) \geq B$.

With the drawings $D^{(l)}$, we construct a drawing of $G \square_L T$ that establishes the upper bound. We define $D_0 = D^{(l_0)}$ and, for $i = 2, \dots, m$, let $D_i = D^{(l_i)} \odot_{\iota_i} D_{i-1}$. If the symmetry condition is satisfied, then we can avoid introducing new crossings in the zip product of the drawings by Lemma 3.1. Also, if the edge $v_i u_i$ is balanced, then there is an apex in $D^{(l_i)}$ that has the same vertex rotation as some cap of u_i in D_{i-1} . We perform the zip product using this apex and by Lemma 3.1 we introduce no new crossings. If neither of the conditions is satisfied, then Lemma 3.2 asserts that at most $\binom{n-1}{2}$ new crossings need to be introduced. The claim follows. \square

If G has no dominating vertex, then the apices of $G^{(i)}$ have two coherent bundles only for $i \geq 3$. The following more general version of Theorem 6.1 follows using the same arguments as in its proof.

Theorem 6.2. *Let T be a tree of order m , $L \subseteq V(T)$ a multiset with $\ell(v) \geq 3$ for every $v \in V(T)$, and G a graph of order n . Define $B = \sum_{v \in V(T)} \text{cr}(G^{(\ell(v))})$. Then, $B \leq \text{cr}(G \square_L T) \leq B + \beta(T) \binom{n-1}{2}$ and $\text{cr}(G \square_L T) = B$ whenever the stabilizer subgroup $\Gamma(v)$ of the automorphism group of G acts as a symmetric group on $V(G) \setminus \{v\}$ for some $v \in V(G)$.*

In the rest of Chapter 6, we list several special cases of the above theorems. The following two corollaries imply equality of $\text{cr}(G \square P_m)$ and $\text{cr}(G \widehat{\square} P_m)$ up to an additive constant.

Corollary 6.3. $\text{cr}(G \widehat{\square} P_m) = (m+1) \text{cr}(G^{(2)})$ for a graph G with a dominating vertex and $m \geq 0$.

Proof. For $G \widehat{\square} P_m$, the multiset L contains precisely the two vertices of P_m of degree one. The claim follows by Theorem 6.1, since all edges of P_m are balanced. \square

Corollary 6.4. *The following inequality holds for a graph G of order n with a dominating vertex and $m \geq 2$:*

$$(m-1) \operatorname{cr}(G^{(2)}) \leq \operatorname{cr}(G \square P_m) \leq (m-1) \operatorname{cr}(G^{(2)}) + 2 \left(\operatorname{cr}(G^{(1)}) + \binom{n-1}{2} \right).$$

Proof. $G \square P_m$ contains $G \widehat{\square} P_{m-2}$ as a subdivision, thus $\operatorname{cr}(G \square P_m) \geq (m-1) \operatorname{cr}(G^{(2)})$ by Corollary 6.3. Let u, v be the caps of $\bar{G} = G \widehat{\square} P_{m-2}$ and v', v'' the apices of two disjoint copies G', G'' of $G^{(1)}$. We observe that $G \square P_m$ is isomorphic to some graph in $(\bar{G}_{u \odot v'} G')_{v \odot v''} G''$ and the claim follows by Lemma 3.2. \square

6.2 Cycles

Lemma 6.5. *Whenever (i) $3 \leq n$ and $1 \leq d \leq 6$, (ii) $3 \leq n \leq 6$ and $1 \leq d$, (iii) $3 \leq n \leq 8$ and $1 \leq d \leq 10$, or (iv) $3 \leq n \leq 10$, $1 \leq d \leq 8$, then $\operatorname{cr}(C_n^{(d)}) = \lfloor \frac{n}{2} \rfloor \lfloor \frac{n-1}{2} \rfloor \lfloor \frac{d}{2} \rfloor \lfloor \frac{d-1}{2} \rfloor$ and, moreover, there exists an optimal drawing of $C_n^{(d)}$ in which the vertex rotation around every apex respects the cyclic ordering imposed by C_n .*

Proof. The graph $C_n^{(d)}$ has $K_{n,d}$ as a subgraph, thus $\operatorname{cr}(C_n^{(d)}) \geq \operatorname{cr}(K_{n,d})$. Kleitman established the crossing number of the latter when (i) or (ii) apply [65], and Woodall established it under conditions (iii) or (iv) [134]. In each of the cases, we can add the edges of the cycle into an optimal drawing of $K_{n,d}$ without introducing new crossings, cf. Figure 6.1 for an example with $n = 7$, $d = 3$. The vertex rotations around the apices in these drawings respect the ordering imposed by C_n . \square

Corollary 6.6. *Let d be the maximum degree in a tree T and n an integer. If one of the conditions (i)–(iv) applies to n, d , then, for $d_v = \deg_T(v)$, $v \in V(T)$,*

$$\operatorname{cr}(C_n \widehat{\square} T) = \sum_{v \in V(T)} \left\lfloor \frac{n}{2} \right\rfloor \left\lfloor \frac{n-1}{2} \right\rfloor \left\lfloor \frac{d_v}{2} \right\rfloor \left\lfloor \frac{d_v-1}{2} \right\rfloor. \quad (6.1)$$

Proof. The proof follows the arguments of the proof of Theorem 6.2, using consistency of vertex rotations around apices in optimal drawings of $C_n^{(d)}$ implied by Lemma 6.5. The major distinction are vertices of degree one and two in T , since the apices of the graph $C_n^{(2)}$ have only one coherent bundle. But $C_n^{(2)}$ is planar, and Lemma 3.5 applies. Equality (6.1) follows by Lemma 6.5. \square

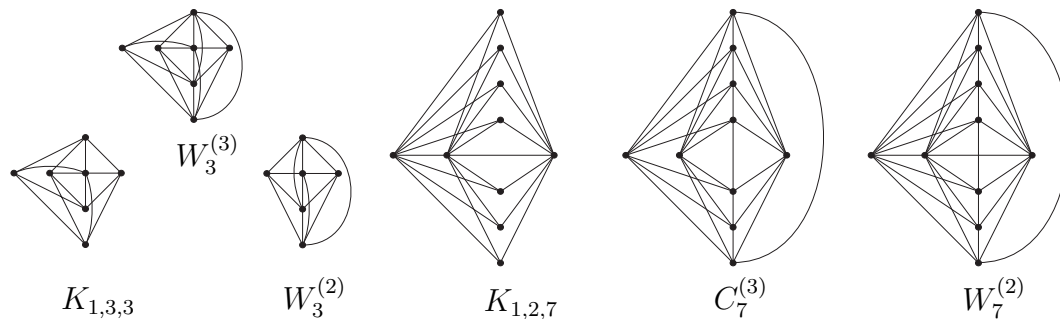

Figure 6.1: Several optimal drawings.

6.3 Stars

The graph $S_n^{(d)}$ is isomorphic to the complete tripartite graph $K_{1,d,n}$, which can be obtained by contracting an edge of $K_{d+1,n+1}$. Also, the graph $S_n \square S_d$ is a subdivision of $S_n^{(d)}$. These observations enable us to express the crossing numbers of Cartesian products of stars with trees as a sum of the crossing numbers of Cartesian products of two stars:

Corollary 6.7. *Let T be a tree and $n \geq 1$. Then, for $d_v = \deg_T(v)$,*

$$\text{cr}(S_n \square T) = \sum_{v \in V(T), d_v \geq 2} \text{cr}(K_{1,d_v,n}).$$

Proof. Let T' be the tree obtained by deleting all the leaves of T and let L be the set of leaves of T' , each leaf v with multiplicity equal to $\deg_T(v) - 1$. The graph $S_n \square T$ is a subdivision of $S_n \square_L T'$ and the claim follows by Theorem 6.1 since $S_n^{(d)}$ is isomorphic to $K_{1,d,n}$. \square

Corollary 6.8. *Let $n \geq 1$ be any integer and T a subcubic tree with n_2 vertices of degree two and n_3 vertices of degree three. Then,*

$$\text{cr}(S_n \square T) = \left\lfloor \frac{n}{2} \right\rfloor \left((n_2 + 2n_3) \left\lfloor \frac{n-1}{2} \right\rfloor + n_3 \right). \quad (6.2)$$

Let T be a tree. Then,

$$\text{cr}(S_3 \square T) = \sum_{v \in V(T), d_v \geq 2} \left\lfloor \frac{d_v}{2} \right\rfloor \left(2 \left\lfloor \frac{d_v-1}{2} \right\rfloor + 1 \right). \quad (6.3)$$

Proof. Asano proved $\text{cr}(K_{1,3,n}) = \lfloor \frac{n}{2} \rfloor (2 \lfloor \frac{n-1}{2} \rfloor + 1)$ in [10]. The equation (6.3) follows by Corollary 6.7.

The graph $K_{1,2,n}$ has $K_{3,n}$ as a subgraph. Kleitman [65] proved that $\text{cr}(K_{3,n}) = \lfloor \frac{n}{2} \rfloor \lfloor \frac{n-1}{2} \rfloor$. Figure 6.1 presents a drawing of $K_{1,2,n}$ with this many crossings ($n = 7$). Another application of Corollary 6.7 yields (6.2). \square

A special case of (6.2) was conjectured by Jendrol' and Ščerbová [57].

Corollary 6.9. $\text{cr}(S_n \square P_m) = (m - 1) \lfloor \frac{n}{2} \rfloor \lfloor \frac{n-1}{2} \rfloor$ for $m, n \geq 1$.

6.4 Wheels

We introduce another operation on graphs that allows us to study the crossing numbers of Cartesian products of wheels. Let $F \subseteq E(G)$ be a subset of edges of G and π a permutation of F . A π -subdivision G^π of G is the graph, obtained from G by subdividing every edge $e \in F$ with the vertex v_e and adding the edges $\{v_e v_{\pi(e)} \mid e \in F\}$.

Theorem 6.10. *Let v be a vertex that has a bundle B_v in a graph G and let π be a cyclic permutation of a subset F of all but one of the edges incident with v , $|F| \geq 3$. Then*

$$\text{cr}(G^\pi) \geq \text{cr}(G) + 1, \quad (6.4)$$

with equality if π respects the edge rotation around v in some optimal drawing of G .

Proof. Let C_v be the cycle on the edges $\{v_e v_{\pi(e)} \mid e \in F\}$ in G^π . Let D^π be an optimal drawing of G^π and D the induced subdrawing of G . The triple (v, B_v, C_v) is a wheel gadget of degree $|F| \geq 3$ in G^π . Assume it has no crossing on C_v in D^π . Then C_v is a simple closed curve in D^π and the whole drawing D^π lies in the same component of $\Sigma - C_v$. Without loss of generality, D^π lies in the exterior of the disk bounded by C_v and by Lemma 4.14 an inner spoke must cross an outer spoke. Let c be the number of crossings on the inner spokes.

Claim 1: *Under the above assumptions, $\text{cr}(D) \geq \text{cr}(G) + c - \lfloor \frac{c}{|F|} \rfloor$.* Let e be some inner spoke with the smallest number of crossings. We draw a new vertex u in the interior of C_v . It is possible to connect u with all vertices of C_v without introducing new crossings and also to detach e from its endvertex on C_v and connect it with u (crossing C_v). Let \bar{D}^π be the modified drawing, presented in Figure 6.2, and let \bar{D} be its subdrawing obtained by removing the rim and all inner spokes but e from \bar{D}^π . In Figure 6.2, we indicate \bar{D} with

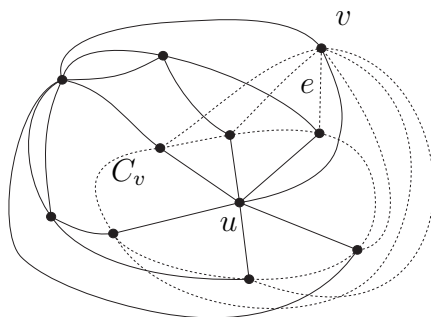
Figure 6.2: Drawings \bar{D}^π and \bar{D} .

the solid edges. Since \bar{D} is a drawing of a subdivision of G and has at least $c - \lfloor \frac{c}{|F|} \rfloor$ crossings less than D , the claim follows.

Either there is a crossing of D^π on C_v , which is not present in D , or $c - \lfloor \frac{c}{|F|} \rfloor \geq 1$. Inequality (6.4) follows.

If π respects the edge rotation around v in an optimal drawing D of G , we can draw C_v in D with at most one new crossing. \square

Lemma 6.11. $\text{cr}(W_n^{(2)}) = \lfloor \frac{n}{2} \rfloor \lfloor \frac{n-1}{2} \rfloor + 1$ for $n \geq 3$.

Proof. The drawing of $G = W_n^{(2)}$ with $k = \lfloor \frac{n}{2} \rfloor \lfloor \frac{n-1}{2} \rfloor + 1$ crossings presented in Figure 6.1 (with $n = 7$) establishes the upper bound.

Let D be an optimal drawing of G for some $n \geq 3$. Partition the edges of G into the edges E_1 of the $K_{3,n}$ subgraph of G , the edges E_2 of the path between the apices u, v of G containing the center w of the wheel, and the edges E_3 of the rim. There are at least $k - 1$ crossings between the edges of E_1 . If there is a crossing involving an edge of E_3 , the claim follows.

Otherwise the rim is drawn as a simple closed curve γ and we may assume that G is drawn in the disk Δ bounded by γ . The edges emanating from each of the vertices u, v , and w do not cross and separate Δ into n disks. For distinct $x, y \in \{u, v, w\}$, there are at least $\lfloor \frac{n}{2} \rfloor \lfloor \frac{n-1}{2} \rfloor$ crossings between edges incident with x and y , implying a contradiction $\text{cr}(D) \geq 3(k - 1)$. \square

Corollary 6.12. $\text{cr}(W_n \square P_m) = (m - 1) \left(\lfloor \frac{n}{2} \rfloor \lfloor \frac{n-1}{2} \rfloor + 1 \right) + 2$ for $m \geq 1$ and $n \geq 3$.

Proof. Two applications of Theorem 6.10 to the graph with two vertices and $n + 1$ parallel edges among them prove the claim in case $m = 1$.

Let u, v be the caps of $G = W_n \widehat{\square} P_{m-2}$ and let F_u (respectively, F_v) contain the edges incident with u (v) and a vertex on the rim of the corresponding wheel in G . Corollary 6.3 and Lemma 6.11 assert $\text{cr}(G) = (m-1) \left(\lfloor \frac{n}{2} \rfloor \lfloor \frac{n-1}{2} \rfloor + 1 \right)$. The graph $W_n \square P_m$ is isomorphic to $G' = (G^\pi)^{\pi'}$ for properly chosen permutations π of F_u and π' of F_v . Theorem 6.10 implies $\text{cr}(G') = \text{cr}(G) + 2$. \square

Lemma 6.13. $\text{cr}(W_3^{(3)}) = 5$.

Proof.

Let $G = W_3^{(3)}$, let D be an optimal drawing of G , and let C be the set of edges of the rim of W_3 . In D , there is no crossing between two edges of C . These therefore bound a disk Δ in D . Then $G - C = S_3^{(3)}$ and let F be the set of edges of S_3 in $G - C$. The result of Asano [10] implies at least three crossings on the edges of $G - C$. If there are two crossings on C , the claim follows.

Assume there is only one crossing on C . If it is a crossing with an edge of F , then the induced drawing of $G - F$ has no crossing on C and we may assume it lies in the interior of Δ . The graph $G - F - C$ is isomorphic to the graph $K_{3,4}$, of which three vertices are incident with C , and four are not, say v_1, \dots, v_4 . The edges emanating from v_i and v_j must cross for distinct $i, j \in \{1, 2, 3, 4\}$. This implies at least six crossings in D .

Assume the only crossing on C is not a crossing with an edge of F , but with an edge e emanating from one of $v_i, i \in \{1, 2, 3, 4\}$. The induced drawing of $G - e$ has no crossing on C , thus we may assume it is drawn in the interior of Δ . By the argument of the previous paragraph, there are at least three crossings between the edges of $K_{3,3}$ subgraph of $G - v_i - C$. If there is an additional crossing on the edges incident with v_i distinct from e , the claim follows. Assume there is none. Then there exists a simple closed curve γ that starts at the center w of the wheel, follows the edge wv_i , continues along an edge connecting v_i with the rim C , along the edges of C , along the other edge connecting v_i and C , and finally closes along v_iw , such that $G - v_i - C$ is drawn inside the disk Δ' bounded by γ . The vertex w is incident with other three vertices on the boundary of Δ' and we may assume two of the edges lie on this boundary. Let f be the third of these edges, which separates the other two neighbors of w in Δ' . There is a drawing of $K_{2,4}$ in Δ' with four vertices on the boundary of Δ' , which has at least two crossings on its edges and at least two crossings with f .

If there are no crossings on C , then we may assume the whole drawing, and in particular the subdrawing of $K_{4,3}$, is in Δ and has at least six crossings.

The claim about $\text{cr}(W_{3,3})$ follows, since Figure 6.1 presents a drawing of $W_3^{(3)}$ with five crossings. \square

Corollary 6.14. *Let T be a subcubic tree with n_i vertices of degree i , $i = 1, 2, 3$. Then, $\text{cr}(W_3 \square T) = n_1 + 2n_2 + 5n_3$.*

Proof. We remove all the leaves from T and obtain a tree T' . Let L be the multiset of leaves of T' , each $v \in L$ with multiplicity equal to $\deg_T(v) - 1$. Thus, $\ell(v)$ with respect to L and T' equals $\deg_T(v)$, which is at least two for every $v \in V(T')$. Since Lemmas 6.11 and 6.13 establish $\text{cr}(W_3^{(2)}) = 2$ and $\text{cr}(W_3^{(3)}) = 5$, Theorem 6.2 implies $\text{cr}(W_3 \square_L T') \geq 2n_2 + 5n_3$. Equality follows as the vertex rotations are consistent in the optimal drawings of $W_3^{(2)}$ and $W_3^{(3)}$ in Figure 6.1. This consistency in combination with Theorem 6.10 also implies that a properly chosen π -subdivision of edges connecting a cap of $W_3 \square_L T'$ with the corresponding rim increases the crossing number by precisely one. To obtain $W_3 \square T$ from $W_3 \square_L T'$, we need one such subdivision for each leaf of T , and the claim follows. \square

Part III

The Minor Crossing Number

Chapter 7

Preliminaries

Two minor-monotone variations of the crossing number invariant are presented in this chapter. They are derived from the ordinary crossing number using general principles of how a graph invariant can be transformed into a minor-monotone graph invariant, as studied by Fijavž [38]. One of the variations bounds the crossing number of a graph from above and the other bounds it from below. As the minimization of the number of crossings and lower bounds on this number are of more general interest, only this second variation is studied in greater detail.

The results of this chapter are based on research conducted by Fijavž, Mohar, and the author [20]. Only few results relating graph minors and the crossing numbers of graphs have been published prior to this work. Moreno and Salazar presented a lower bound on the crossing numbers of graphs in terms of their minors with a small maximum degree [86]. This result is generalized in Section 8.1. Robertson and Seymour [109] determined the forbidden minors for being a minor of a graph having crossing number at most one. The minor crossing number introduced in the following section generalizes this concept; these graphs are the forbidden minors for having minor crossing number at most one. The structure of drawings used to obtain this result is generalized to graphs with larger minor crossing numbers and applied in Chapter 9 to improve a lower bound on the minor crossing number of a graph using the number of its edges. Another related result is the proof of Hliněný that shows the crossing number problem is *NP*-hard for cubic graphs [55]. As subdivisions of graphs (which do not affect crossing numbers) are equivalent to minors for cubic graphs, this result implies that the minor-monotone variant of the crossing number problem is *NP*-hard. The fact that for a cubic graph the crossing number equals the minor crossing number generates additional interest to studying the crossing numbers of such graphs. Some research in this direction was conducted by McQuillan and Richter [81, 98].

7.1 Definitions and basic lemmas

For a given graph G , the *minor crossing number* is defined as the minimum crossing number over all graphs that contain G as a minor:

$$\text{mcr}(G, \Sigma) := \min \{ \text{cr}(H, \Sigma) \mid G \leq_m H \} . \quad (7.1)$$

By $\text{mcr}(G)$ we denote $\text{mcr}(G, \mathbb{S}_0)$.

Similarly, the *major crossing number* of G is the maximum crossing number taken over all minors of G :

$$\text{Mcr}(G, \Sigma) := \max \{ \text{cr}(H, \Sigma) \mid H \leq_m G \} . \quad (7.2)$$

The following lemmas follow directly from the definitions:

Lemma 7.1. $\text{mcr}(G, \Sigma) \leq \text{cr}(G, \Sigma) \leq \text{Mcr}(G, \Sigma)$ for every graph G and every surface Σ .

Lemma 7.2. $\text{mcr}(G, \Sigma) \leq \text{mcr}(H, \Sigma)$ and $\text{Mcr}(G, \Sigma) \leq \text{Mcr}(H, \Sigma)$ for every surface Σ , whenever G is a minor of H .

Proof. The minimum in the definition of $\text{mcr}(H, \Sigma)$ is taken over a subset of graphs considered for $\text{mcr}(G, \Sigma)$. This proves the first inequality. Similarly, $\text{Mcr}(G, \Sigma)$ is the maximum over a subset of graphs considered for $\text{Mcr}(H, \Sigma)$. \square

Let $\omega(k, \Sigma) = \{G \mid \text{mcr}(G, \Sigma) \leq k\}$ be the family of graphs G with bounded $\text{mcr}(G, \Sigma)$ and let $\Omega(k, \Sigma) = \{G \mid \text{Mcr}(G, \Sigma) \leq k\}$ be the family of graphs G with bounded $\text{Mcr}(G, \Sigma)$. Lemma 7.2 immediately yields:

Corollary 7.3. Let $k \geq 0$ be an integer and Σ a surface. The families $\omega(k, \Sigma)$ and $\Omega(k, \Sigma)$ are minor-closed.

For each graph G , there exists a graph \bar{G} such that $\text{mcr}(G, \Sigma) = \text{cr}(\bar{G}, \Sigma)$ and $G \leq_m \bar{G}$. We call such a graph \bar{G} a *realizing graph* of G and an optimal drawing of \bar{G} in Σ is called a *realizing drawing* of G (with respect to Σ). Realizing graphs and drawings are by no means uniquely determined, but we shall always assume that G and \bar{G} have the same number of connected components.

As G is a minor of its realizing graph \bar{G} , G can be obtained by a series of contractions from a subgraph of \bar{G} . In other words, $G = (\bar{G} - R)/C$ for suitable edge sets $R, C \subseteq E(\bar{G})$. It is clear that every graph G has a realizing graph \bar{G} such that $R = \emptyset$. For each vertex $v \in V(G)$, there is a unique maximal tree

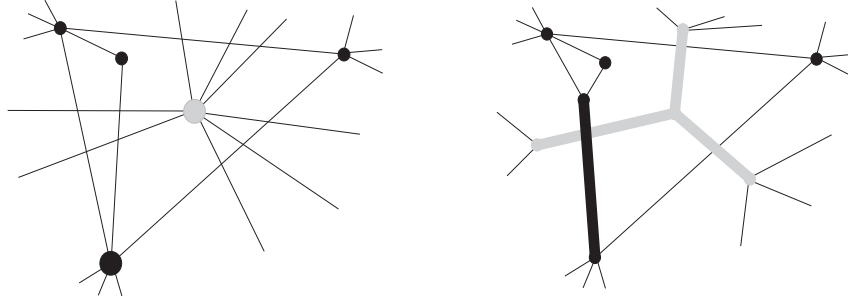

Figure 7.1: mcr as an extension of cr.

$T_v \leq \bar{G}[C]$ that is contracted to v . In the following figures, the original edges will be drawn as thin lines and the contracted edges as thick lines.

The minor crossing number can be considered a natural extension of the usual crossing number. Clearly, if $e, f \in E(\bar{G})$ cross in a realizing drawing of G , then $e, f \in C \cup E(G)$. If both e and f belong to C , then their crossing is a *vertex-vertex crossing*, but if both belong to $E(G)$, then their crossing is in an *edge-edge crossing*. Otherwise, their crossing is an *edge-vertex crossing*. This is illustrated in Figure 7.1. All crossings in the realizing drawing can be forced to be vertex-vertex crossings by subdividing the original edges appropriately.

7.2 Cubic realizing graphs

If G is a cubic graph, then $\text{mcr}(G, \Sigma) = \text{cr}(G, \Sigma)$. The following proposition shows that a study of the crossing numbers of cubic graphs is closely related to the minor crossing numbers of the graphs that have these graphs as minors.

Proposition 7.4. *For every graph G and every surface Σ there exists a cubic realizing graph H . Moreover, if $\delta(G) \geq 3$, then G can be obtained from H by contracting edges only. Further, if G is simple, then H is simple, otherwise there exists a simple cubic realizing graph H' of G .*

Proof. Let H_0 be a realizing graph of G without removed edges and let $D_0 = (\varphi, \varepsilon)$ be an optimal drawing of H_0 . We shall describe H in terms of its drawing D obtained from D_0 . For each vertex v of H_0 of degree $d := \deg_{H_0}(v) \neq 3$, let U_v be a closed disk containing $\varphi(v)$ in its interior, which satisfies the following conditions: (i) a small neighborhood of U_v contains no crossings, (ii) U_v is disjoint from U_u for every $u \in V(H_0) \setminus \{v\}$, and (iii) $U_v \cap \varepsilon(E(H_0))$ is connected.

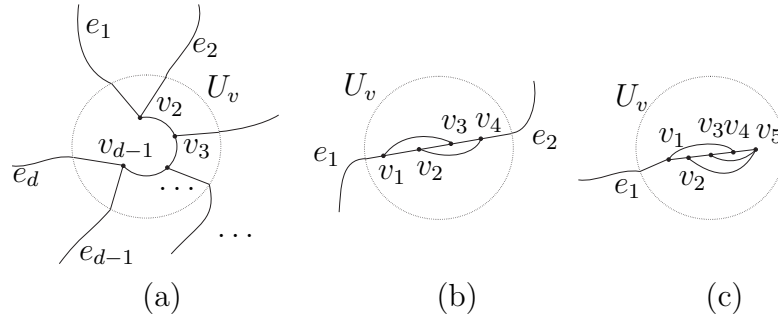

Figure 7.2: Drawing a cubic realizing graph.

For the cases $d > 3$, $d = 2$, and $d = 1$, we modify D_0 in U_v as indicated in Figure 7.2. Let D be this new drawing and H the graph defined by D .

Clearly, $G \leq_m H$, so $\text{cr}(H, \Sigma) \geq \text{mcr}(G, \Sigma)$. The fact that D contains no new crossings implies $\text{mcr}(G, \Sigma) = \text{cr}(H_0, \Sigma) = \text{cr}(D, \Sigma) \geq \text{cr}(H, \Sigma)$. A combination of these two inequalities proves $\text{cr}(H, \Sigma) = \text{mcr}(G, \Sigma)$.

If $\delta(G) \geq 3$, then we can assume $\delta(H_0) \geq 3$. This implies $|E(H)| - |V(H)| = |E(H_0)| - |V(H_0)|$. Since $H_0 \leq_m H$, the graph G can be obtained from H by contracting edges only.

If G is simple, we may assume H_0 is simple. The construction did not introduce any new parallel edges, so H is simple. If G is not simple, then H may have some parallel edges. These may be subdivided without changing the crossing number and the new vertices of degree two can be replaced as in Figure 7.2 (b). The resulting graph H' is simple and cubic. The same arguments as before show $\text{cr}(H', \Sigma) = \text{cr}(H, \Sigma) = \text{mcr}(G, \Sigma)$. \square

Chapter 8

Bounds on the minor crossing number

Several graph invariants are used in this chapter to yield general lower bounds on the minor crossing numbers of graphs. Section 8.1 relates the minor crossing numbers and the ordinary crossing numbers in terms of the maximum degree of graphs. Section 8.2 bounds the minor crossing numbers from below using the genus of graphs. Finally, Section 8.3 bounds the minor crossing numbers of graphs in terms of the minor crossing numbers of their components and blocks. The lower bounds are applied to several families of graphs in Chapter 10. As explained in Section 2.6, lower bounds on minor crossing numbers may be of interest in VLSI design.

8.1 Using the maximum degree

In this section, we present a generalization of the following result of Moreno and Salazar:

Theorem 8.1 ([86]). *Let G be a minor of a graph H with $\Delta(G) \leq 4$. Then, $\frac{1}{4} \text{cr}(G, \Sigma) \leq \text{cr}(H, \Sigma)$ for every surface Σ .*

Suppose that $G = H/e$ for $e = v_1v_2 \in E(H)$. For $i = 1, 2$, let $d_i = \deg_H(v_i) - 1$ be the number of the edges incident with v_i and distinct from e . We may assume that $d_1 \leq d_2$. As shown in Figure 8.1, any given drawing of H can be changed into a drawing of G such that every crossing involving e is replaced by d_1 new crossings.

More generally, let G be a minor of H . We assume that $G = (H - R)/C$, which implies $E(G) = E(H) \setminus (R \cup C)$. Let D_H be a drawing of H . Then D_H determines a drawing of $H - R$ in Σ in which no new crossings arise. On

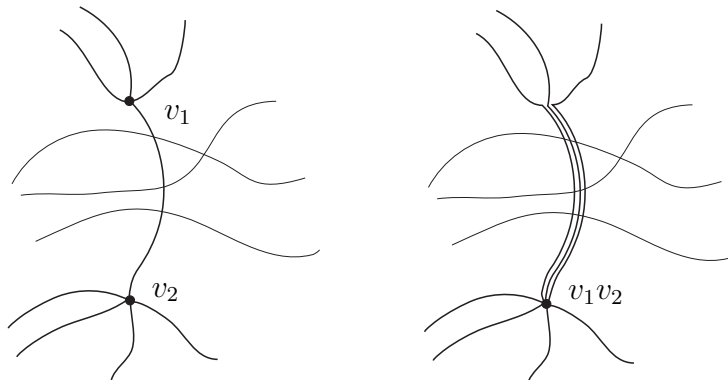

Figure 8.1: Contracting edges on a drawing.

the other hand, by contracting the edges in C , the number of crossings can increase. If we perform edge-contractions one-by-one and every time apply the redrawing procedure described above, we can control the number of new crossings. To do the counting properly, we introduce some additional notation.

Define $w(G, H) : E(H) \rightarrow \mathbb{N}$ by setting $w(G, H, e) = 0$ if $e \in R$ and $w(G, H, e) = 1$ if $e \in E(G)$. If $e \in C$, then let T_v be the maximal tree induced by C containing e . Let T_1 and T_2 be the components of $T_v - e$ and let d_i , $i = 1, 2$, denote the number of edges in $E(G)$ incident with T_i . Set $w(G, H, e) = \min\{d_1, d_2\}$. For $e \in E(H)$, we call $w(G, H, e)$ the *weight* of e .

Let $G \leq_m H_1 \leq_m H$, so that $G = (H_1 - R_1)/C_1$, $H_1 = (H - R')/C'$, and $G = (H - R)/C$, where $R = R_1 \cup R'$ and $C = C_1 \cup C'$. Let D_H be a drawing of H . Furthermore, let D_1 be a drawing of H_1 obtained from D_H by removing the edges of R' and applying the described contractions of the edges in C' one after another. When performing these contractions, we proceed as shown in Figure 8.1 except that the criterion determining whether we contract towards v_1 or v_2 is not the degree of v_1 or v_2 , but the quantity d_1 or d_2 introduced in the previous paragraph. Similarly, let D_G be obtained from D_1 by using R_1 and C_1 .

Lemma 8.2. *Let G, H, H_1 and their drawings D_G, D_H, D_1 be as defined in the previous paragraph. Then,*

$$\sum_{x \in X(D_1)} w(G, H_1, e_x) w(G, H_1, f_x) \leq \sum_{x \in X(D_H)} w(G, H, e_x) w(G, H, f_x). \quad (8.1)$$

Proof. It is enough to prove this for the case when H_1 and H differ only by a single minor operation with respect to G , i.e. $R' \cup C' = \{e\}$. The general

statement then follows by induction. If $H_1 = H - e$, then $w(G, H, e) = 0$ and the sums are equal.

Suppose that $H_1 = H/e$. As simplifying the image of e decreases the right sum, we may assume that $\varepsilon_H(e)$ is a simple arc. We adopt the notation introduced above. The edge e is contracted, so $e \in C$. After the contraction of e , all weights remain the same, i.e. $w(G, H_1, f) = w(G, H, f)$ for every $f \in E(H) - e$. Hence, the difference between the left and the right side in (8.1) is that the crossings of e in D_H are replaced by the newly introduced crossings in D_1 (as shown in Figure 8.1). Let $x \in X(D_H)$ with $e_x = e = v_1v_2$ and let E_1 be the set of edges incident with v_1 . Since $\sum_{f \in E_1 - e} w(G, H_1, f) = \sum_{f \in E_1 - e} w(G, H, f) = w(G, H, e)$ and to each crossing x of e with some e' in D_1 correspond exactly the crossings of $E_1 - e$ with the edge e' , the inequality (8.1) follows. \square

Theorem 8.3. *Let G be a minor of a graph H , Σ a surface, and $\tau := \lfloor \frac{1}{2}\Delta(G) \rfloor$. Then,*

$$\text{cr}(G, \Sigma) \leq \tau^2 \text{cr}(H, \Sigma).$$

Proof. Let D_H be an optimal drawing of H and let D_G be the drawing of G , obtained from D_H as described before Lemma 8.2. We apply Lemma 8.2 with $H_1 = G$. Obviously, $\text{cr}(G, \Sigma) \leq \text{cr}(D_G, \Sigma)$. As all the edges in G have weight $w(G, G, e) = 1$, the left side of inequality (8.1) equals the number of crossings in D_G . Since the weights $w(G, H, e)$ of the edges in H are bounded from above by τ , the theorem follows. \square

We obtain the following corollary by using Theorem 8.3 together with definition (7.1) and Lemma 7.2.

Corollary 8.4. *Let G be a graph, Σ a surface, and $\tau := \lfloor \frac{1}{2}\Delta(G) \rfloor$. Then,*

$$\text{mcr}(G, \Sigma) \leq \text{cr}(G, \Sigma) \leq \tau^2 \text{mcr}(G, \Sigma).$$

Corollary 8.5. *Let G be a graph, Σ a surface, and $\tau := \lfloor \frac{1}{2}\Delta(G) \rfloor$. Then,*

$$\frac{1}{\tau^2} \text{Mcr}(G, \Sigma) \leq \text{cr}(G, \Sigma) \leq \text{Mcr}(G, \Sigma).$$

8.2 Using the genus

In this section we derive some genus-related lower bounds for the minor crossing numbers of graphs.

Theorem 8.6. *Let G be a graph with genus $g(G)$ and nonorientable genus $\tilde{g}(G)$. If Σ is an orientable surface of genus $g(\Sigma)$, then $\text{mcr}(G, \Sigma) \geq g(G) - g(\Sigma)$ and $\text{mcr}(G, \Sigma) \geq \tilde{g}(G) - 2g(\Sigma)$.*

If Σ is a nonorientable surface with genus $g(\Sigma)$, then $\text{mcr}(G, \Sigma) \geq \tilde{g}(G) - g(\Sigma)$.

Proof. Let D be an optimal drawing of a realizing graph \bar{G} in an orientable surface Σ . For each crossing in D , we add a handle to Σ and obtain an embedding of \bar{G} in a surface Σ' of genus $g(\Sigma') = g(\Sigma) + \text{mcr}(G, \Sigma)$. Using minor operations on D , we can obtain an embedding of G in Σ' , which yields $g(\Sigma') \geq g(G)$. Thus, we have $\text{mcr}(G, \Sigma) \geq g(G) - g(\Sigma)$.

The other two claims can be proven in a similar way by adding crosscaps at the crossings of D . Note that adding a crosscap to an orientable surface of genus g results in a surface of nonorientable genus $2g + 1$. \square

When the genus of a graph is not known, one can derive the following lower bound using the Euler Formula and the same technique as in the preceding proof.

Proposition 8.7. *Let G be a graph with $n = |V(G)|$, $m = |E(G)|$, and girth r and let Σ be a surface of Euler genus g . Then, $\text{mcr}(G, \Sigma) \geq \frac{r-2}{r}m - n - g + 2$.*

Proof. As in the proof of Theorem 8.6 we obtain an embedding D of G in \mathbb{N}_{g+k} , where $k = \text{mcr}(G, \Sigma)$. Let f be the number of faces in D . All faces have length at least r , thus $f \leq \frac{2m}{r}$. The Euler Formula results in $2 - (g + k) = n - m + f \leq n - \frac{r-2}{r}m$, which yields the claimed bound. \square

For an improvement over Proposition 8.7 see Theorem 9.6. The following proposition relates the minor crossing numbers in different surfaces with those in the plane.

Proposition 8.8. *The inequality $\text{mcr}(G, \Sigma) \leq \max(0, \text{mcr}(G) - g(\Sigma))$ holds for every surface Σ and every graph G , where $g(\Sigma)$ denotes the (non)orientable genus of Σ .*

Proof. We start with a realizing drawing of G in the sphere and remove at least one existing crossing by adding either a crosscap (if the surface is nonorientable) or a handle. This increases the genus of the surface by one and the result follows. \square

The minor crossing numbers of G in two different surfaces Σ and Σ' could be related in a similar fashion.

8.3 Using the connected components

Let G_1, \dots, G_k be the components of a graph G . It is easy to see that $\text{mcr}(G) = \sum_{i=1}^k \text{mcr}(G_i)$. We shall extend this fact to the blocks (2-connected components) of G , even in the setting of the minor crossing number in a surface.

Let Σ be a surface and k a positive integer. We say that a collection $\Sigma_1, \dots, \Sigma_k$ of surfaces is a *decomposition* of Σ , and write $\Sigma = \Sigma_1 \# \dots \# \Sigma_k$, if Σ is homeomorphic to the connected sum of $\Sigma_1, \dots, \Sigma_k$.

Theorem 8.9. *Let Σ be a surface and let G be a graph with blocks G_1, \dots, G_k . Then,*

$$\sum_{i=1}^k \text{mcr}(G_i, \Sigma) \leq \text{mcr}(G, \Sigma) \leq \min \left\{ \sum_{i=1}^k \text{mcr}(G_i, \Sigma_i) \mid \Sigma = \Sigma_1 \# \dots \# \Sigma_k \right\}. \quad (8.2)$$

Proof. Let D be an optimal drawing of a realizing graph \tilde{G} in Σ . It contains an induced subdrawing D_i of some graph \tilde{G}_i with G_i as a minor for every $i = 1, \dots, k$. The graphs G_i and G_j , $i \neq j$, are either disjoint (implying \tilde{G}_i and \tilde{G}_j are disjoint), or they have a cutvertex v in common (implying that \tilde{G}_i and \tilde{G}_j intersect in a subgraph of the tree T_v). Since there are at least $\text{mcr}(G_i, \Sigma)$ crossings in D_i and there are no crossings in the subdrawing induced by T_v for any $v \in V(G)$, the lower bound follows.

We use the block-cutvertex forest of G to reorder the blocks of G in such way that, for $i = 2, \dots, k$, the block G_i shares at most one vertex with the graph $H_i := \bigcup_{j=1}^{i-1} G_j$.

Let $\Sigma_1, \dots, \Sigma_k$ be a decomposition of the surface Σ , which attains the minimum $\sum_{i=1}^k \text{mcr}(G_i, \Sigma_i)$. For $i = 1, \dots, k$, let the D_i be some optimal drawing of \tilde{G}_i in Σ_i . We set $\tilde{D}_1 = D_1$, $\tilde{H}_1 = \tilde{G}_1$, and $\Pi_1 = \Sigma_1$. For $i = 2, \dots, k$, we choose a face f_i of \tilde{D}_{i-1} in Π_{i-1} and f'_i of D_i in Σ_i . If H_{i-1} and G_i share a vertex v , then we choose f_i incident with some vertex x_i of $T_v \leq \tilde{H}_{i-1}$ and f'_i incident with some vertex y_i of $T_v \leq \tilde{G}_i$, otherwise the choice can be arbitrary. By constructing a connected sum of faces f_i, f'_i and, if necessary, connecting x_i with y_i in the new face $f_i \# f'_i$, we obtain a drawing \tilde{D}_i of \tilde{H}_i in $\Pi_i := \Pi_{i-1} \# \Sigma_i$.

It is clear that $G \leq_m \tilde{H}_k$ and that \tilde{D}_k is a drawing of \tilde{H}_k in Σ with at most $\sum_{i=1}^k \text{mcr}(G_i, \Sigma_i)$ crossings. This proves the upper bound. \square

The fact that \mathbb{S}_0 has only trivial surface decompositions implies the following:

Corollary 8.10. *Let G be a graph with blocks G_1, \dots, G_k . Then,*

$$\text{mcr}(G) = \sum_{i=1}^k \text{mcr}(G_i).$$

Proof. To prove this, one has to observe that the left-hand side and the right-hand side of the inequalities in Theorem 8.9 are equal for $\Sigma = \mathbb{S}_0$. \square

The strictness of the upper bound in Theorem 8.9 is open for surfaces other than \mathbb{S}_0 .

Chapter 9

Structure of graphs with bounded $\text{mcr}(G, \Sigma)$

As mentioned in Chapter 7, the family $\omega(k, \Sigma)$ of all graphs with $\text{mcr}(G, \Sigma)$ at most k is minor-closed. Let us denote by $F(k, \Sigma)$ the set of minimal forbidden minors for $\omega(k, \Sigma)$. Also, let $F(k)$ and $\omega(k)$ stand for $F(k, \mathbb{S}_0)$ and $\omega(k, \mathbb{S}_0)$, respectively.

The graphs in $\omega(0, \Sigma)$ have a simple topological characterization – they are precisely the graphs that can be embedded in Σ . A similar topological characterization holds for graphs in $\omega(1)$. They are precisely the graphs that can be embedded in the projective plane with face-width at most two. This was observed by Robertson and Seymour in [109], where they determined the set $F(1)$ of minimal forbidden minors for $\omega(1)$:

Theorem 9.1 ([109]). *The set $F(1)$ contains precisely the 41 graphs G_1, \dots, G_{35} and Q_1, \dots, Q_6 , where G_1, \dots, G_{35} are the minimal forbidden minors for embeddability in the projective plane and Q_1, \dots, Q_6 are the projective planar graphs that can be obtained from the Petersen graph by successively applying the $Y\Delta$ and ΔY transformations.*

This theorem establishes the following linear time algorithm for testing if $\text{mcr}(G) \leq 1$: first embed G in the projective plane [84] and then check whether the face-width of the embedding is less than or equal to two [59].

Let us remark that the forbidden minors for the projective plane have been determined by Glover, Huneke, and Wang [44] and Archdeacon [8]. There are seven graphs that can be obtained from the Petersen graph by $Y\Delta$ and ΔY operations (known as the Petersen family), but one of them is a forbidden minor for the projective plane.

We will prove that every family $\omega(k, \Sigma)$ has a similar topological representation, for which we need some further definitions.

9.1 Systems of curves

Let γ be a one-sided simple closed curve in a nonorientable surface Σ of Euler genus g . Cutting Σ along γ and pasting a disk to the resulting boundary yields a surface of Euler genus $g - 1$, denoted by Σ/γ . We say that Σ/γ is obtained from Σ by *annihilating* a crosscap at γ .

Let us call a set of pairwise noncrossing, one-sided, simple closed curves $\Gamma = \{\gamma_1, \dots, \gamma_k\}$ in a nonorientable surface Σ a *k-system* in Σ . It is easy to see that the surface $(\Sigma/\gamma_i)/\gamma_j$ is homeomorphic to $(\Sigma/\gamma_j)/\gamma_i$ for distinct $\gamma_i, \gamma_j \in \Gamma$. Therefore the order in which we annihilate the crosscaps at prescribed curves is irrelevant and we define $\Sigma/\Gamma := \Sigma/\gamma_1/\dots/\gamma_k$. We say that the *k-system* Γ in Σ is an *orienting k-system* if the surface Σ/Γ is orientable.

Suppose that D is a drawing of G in a nonorientable surface Σ with at most c crossings. If there exists an (orienting) *k-system* Γ in Σ with each $\gamma \in \Gamma$ intersecting D in at most two points, then we say that D is (orientably) *(c, k)-degenerate*, and we call Γ an (orienting) *k-system* of D . If $c = 0$, then D is an embedding and we also say that it is *k-degenerate*. Note that an embedding of a graph in the projective plane is 1-degenerate precisely when the face-width of the embedding is at most two.

Lemma 9.2. *Let Σ be an (orientable) surface of Euler genus g and let $k \geq 1$ be an integer. Then, for any $l \in \{1, \dots, k\}$, the family $\omega(k, \Sigma)$ consists precisely of all those graphs $G \in \omega(k - l, \mathbb{N}_{g+l})$ for which there exists a graph \tilde{G} that contains G as a minor and that can be drawn in the nonorientable surface \mathbb{N}_{g+l} of Euler genus $g + l$ with (orienting) degeneracy $(k - l, l)$.*

Proof. Let $G \in \omega(k, \Sigma)$ and let \tilde{G} be its realizing graph, drawn in Σ with at most k crossings. Choose a subset of l crossings of \tilde{G} . By replacing a small disk around each of the chosen crossings with a Möbius band, we obtain a drawing of \tilde{G} in \mathbb{N}_{g+l} with (orienting) degeneracy $(k - l, l)$. The replacement at one such crossing and the corresponding curve annihilating the crosscap are illustrated in Figure 9.1.

For the converse, we first prove the induction basis $l = 1$. Let \tilde{G} be the graph that contains G as a minor and is drawn in \mathbb{N}_{g+1} with at most $k - 1$ crossings and let us assume that an (orienting) one-sided curve γ intersects the drawing of \tilde{G} in at most two points, x and y . After cutting the surface along γ and pasting a disk Δ on the resulting boundary, we get a surface of Euler genus g . On the boundary of Δ , two copies of x and y interlace. By adding paths P_x and P_y to join the copies of x and y , respectively, we obtain a drawing D' of a graph G' , which contains \tilde{G} (and hence also G) as a minor. Clearly, D' is a drawing in Σ and has one crossing more than the drawing of \tilde{G} (the one between P_x and P_y). As D' has at most k crossings, $G \in \omega(k, \Sigma)$.

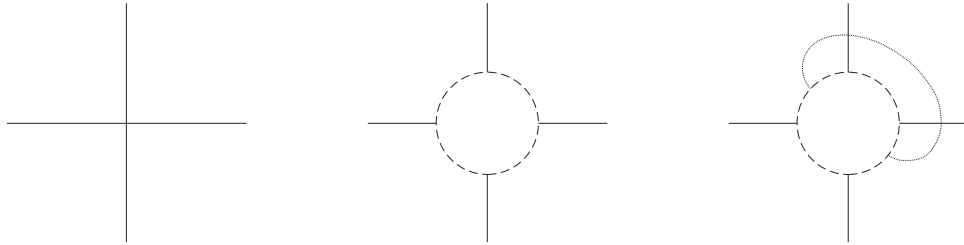

Figure 9.1: Replacing a crossing by a crosscap and a respective annihilating curve.

If $l \geq 2$, we may annihilate the crosscaps consecutively, since the curves in the corresponding l -system are noncrossing. Note that if the l -system is orienting, we obtain an orientable surface Σ . \square

Lemma 9.3. *Let \tilde{G} be a graph with an (orientably) k -degenerate embedding in a surface Σ . If G is a surface minor of \tilde{G} , then G is also (orientably) k -degenerate.*

Proof. It suffices to verify the claim for edge-deletions and edge-contractions. For edge-deletions, there is nothing to prove. For edge contractions, we verify that a k -system for \tilde{G} can be transformed into a k -system for \tilde{G}/e , $e = uv$.

Let Γ be a k -system of \tilde{G} and let $\Gamma_e \subseteq \Gamma$ contain the curves of Γ that intersect e . If $\gamma \in \Gamma_e$ intersects e twice, we may replace γ in Γ by a curve that does not intersect G at all. We may thus assume that each $\gamma \in \Gamma_e$ intersects e exactly once. Let $t = |\Gamma_e|$, let x_1, \dots, x_t be the points of intersection of e with curves in Γ_e , and let $x_0 = u$, $x_{t+1} = v$. By contracting segments $x_i x_{i+1}$, $i = 0, \dots, t$ we obtain an embedding of \tilde{G}/e in which the curves of Γ_e are modified to touch at the new vertex, obtained by the contraction of e . Thus, the modified curves of Γ form a k -system of \tilde{G}/e . \square

If we restrict edge-contraction to edges that are not involved in crossings, Lemma 9.3 can be extended to drawings with crossings.

9.2 Structure theorem

A direct consequence of Lemmas 9.2 and 9.3 is the following:

Theorem 9.4. *Let Σ be an (orientable) surface of Euler genus g and let $k \geq 1$ be an integer. Then, $\omega(k, \Sigma)$ consists of precisely all the graphs that can*

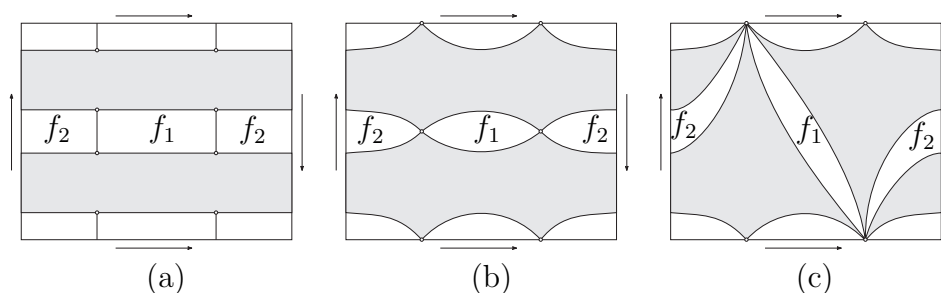

Figure 9.2: Embeddings in the Klein bottle with orienting degeneracy 2.

be embedded in the nonorientable surface \mathbb{N}_{g+k} of Euler genus $g + k$ with (orienting) degeneracy k .

Proof. Let G be embedded in \mathbb{N}_{g+k} with (orienting) degeneracy k . Then $G \in \omega(k, \Sigma)$ by Lemma 9.2.

Let $G \in \omega(k, \Sigma)$. By Lemma 9.2, there exists a graph $\tilde{G} \in \omega(k, \Sigma)$ that has G as a minor and has a k -degenerate embedding in \mathbb{N}_{g+k} . Then G has such embedding by Lemma 9.3. \square

Figure 9.2 (a) exhibits the geometric structure of a realizing graph in the Klein bottle, (b) shows the general structure of its minors G with $\text{mcr}(G) \leq 2$, and (c) is a degenerate example of this structure in which the curves of the corresponding 2-system $\{\gamma_1, \gamma_2\}$ touch twice.

Theorem 9.4 can be used to express a more intimate relationship between the graphs in $\omega(k, \Sigma)$ and $\omega(0, \Sigma)$.

Corollary 9.5. *Let Σ be a surface of Euler genus g , $k \geq 0$ an integer, and let $G \in \omega(k, \Sigma)$. Then there exists a graph H , which embeds in Σ , such that G can be obtained from H by identifying at most k pairs of vertices.*

Proof. Let $G \in \omega(k, \Sigma)$. Then G has an (orientably) k -degenerate embedding in \mathbb{N}_{g+k} by Theorem 9.4. Let Γ be a corresponding (orientable) k -system. We may assume that all the intersections of curves in Γ with G are at the vertices of G , thus each $\gamma \in \Gamma$ intersects G in at most two vertices.

Assume first that $\Gamma = \{\gamma\}$ and that γ intersects G at the vertices u, v . We cut \mathbb{N}_{g+1} along γ and paste a disk Δ to the boundary of the cut surface. We thus obtain an embedding of a graph G' in Σ that has the vertices u, v, u', v' on the boundary of Δ . We add the edge uu' and contract it to obtain a graph H embedded in Σ . Then G is obtained from H by identifying the vertices v and v' .

As the curves in Γ are pairwise noncrossing, we may resolve the case $|\Gamma| > 1$ by induction. \square

9.3 Improved bound

Theorem 9.4 can be used to improve the lower bound of Proposition 8.7.

Theorem 9.6. *Let G be a simple graph with $n = |V_G|$, $m = |E_G|$ and let Σ be a surface of Euler genus g . Then,*

$$\text{mcr}(G, \Sigma) \geq \frac{1}{2}(m - 3(n + g) + 6).$$

We need two technical lemmas to prove this result. Let Σ be a closed surface and $x, y \in \Sigma$. Let $\Gamma = \{\gamma_1, \dots, \gamma_k\}$ be a k -system of onesided noncrossing simple closed curves in Σ such that $\gamma_i \cap \gamma_j = \{x, y\}$ for all $1 \leq i < j \leq k$. Let $\gamma_i = \gamma_i^1 \cup \gamma_i^2$ where γ_i^l is an arc from x to y . If a curve $\gamma_i^l \cup \gamma_j^m$ ($i \neq j$) bounds a disk in Σ whose interior contains no segment of curves in Γ , then we say that $\gamma_i^l \cup \gamma_j^m$ is a Γ -digon.

Lemma 9.7. *A k -system Γ has at most $k - 1$ Γ -digons.*

Proof. Let us contract one of the segments, say γ_1^1 . Then each other γ_i^l becomes a loop in Σ . Since Γ is a k -system of onesided noncrossing loops, the loops in Γ generate a k -dimensional subspace of the first homology group $H_1(\Sigma; \mathbb{Z}_2)$. Therefore, the $2k - 1$ loops $L = \{\gamma_i^l \mid 1 \leq i \leq k, l = 1, 2\} \setminus \{\gamma_1^1\}$ also generate at least k -dimensional subspace. If there are k Γ -digons, then k of the loops could be removed from L and the remaining $k - 1$ loops would still generate the same k -dimensional subspace. This contradiction completes the proof. \square

Let G be a graph and D its k -degenerate embedding in a surface Σ . Let $\Gamma = \{\gamma_1, \dots, \gamma_k\}$ be the corresponding k -system of D . The curves γ_i are pairwise noncrossing, so we may assume that γ_i and γ_j ($i \neq j$) intersect (touch) only in points where they intersect the graph. We modify the curves in Γ so that they intersect D only at vertices. If γ_i intersects D at vertices u_i and v_i , we add to D two new edges e_i, f_i with endvertices u_i, v_i whose embedding in Σ coincides with γ_i . (If $u_i = v_i$, we add one loop e_i at v_i .) We call the resulting embedding D' a k -augmented embedding of D and the corresponding graph G' a k -augmented graph of G (with respect to Γ). Note that G is a subgraph of G' .

Lemma 9.8. *Let D be a k -degenerate embedding of a simple graph G in a nonorientable surface Σ and let D' be a k -augmented embedding of D . Then, D' has at most k faces of length two and has no faces of length one.*

Proof. Since G is a simple graph, any face of length one or two involves some edge e_i, f_i ($i \in \{1, \dots, k\}$). If e_i is a loop, it cannot bound a face since γ_i is a one-sided curve in Σ . Two loops cannot form a facial boundary, since then they would be homotopic, but homotopic one-sided curves always cross each other. An edge e_i or f_i can thus be a part of a face of length two only when $u_i \neq v_i$.

For simplicity of notation, suppose that $\gamma_1, \dots, \gamma_t$ all contain the same pair of vertices u_1 and v_1 . It suffices to show that the edges e_i, f_i ($i = 1, \dots, t$) and possible edge $e_0 = u_1v_1$ of G together form at most t faces of length two. By Lemma 9.7, $\{e_i, f_i \mid 1 \leq i \leq t\}$ form at most $t - 1$ faces of length two, and e_0 can give rise to one additional such face. The application of this argument to all pairs u_i, v_i completes the proof of the lemma. \square

With these two Lemmas in hand, we are prepared to prove Theorem 9.6.

Proof of Theorem 9.6. Let $\text{mcr}(G, \Sigma) = k$. By Theorem 9.4, there exists an embedding D of G in \mathbb{N}_{g+k} with crossing degeneracy k . Let D' be a k -augmented embedding of D . By Lemma 9.8, removing at most k edges from D' yields an embedding D'' without faces of length two, implying $|F_{D''}| \leq \frac{2}{3}|E_{D''}|$. The Euler Formula implies $n - |E_{D''}| + |F_{D''}| = 2 - (g + k)$ and the stated inequality follows. \square

The extension of the bound of Proposition 8.7 for graphs of girth $r \geq 4$ requires additional arguments.

Chapter 10

Applications to families of graphs

In this chapter, we apply the lower bounds on the minor crossing number developed in the preceding chapters to several families of graphs. In general, Theorem 8.3 yields better bounds for graphs of small maximum degree (cubes, $C_m \square C_n$), while Theorem 8.6 suits graphs with large maximum degree better, e.g. complete bipartite graphs. Theorem 9.6 performs best on dense graphs of girth three, e.g. complete graphs.

10.1 Complete graphs

Both Theorem 8.6 and Theorem 9.6 imply the following inequality, which is sharp for $n \in \{3, \dots, 8\}$, as demonstrated in Figure 10.1:

Proposition 10.1. $\text{mcr}(K_n) \geq \lceil \frac{1}{4}(n-3)(n-4) \rceil$ for $n \geq 3$.

The following proposition establishes an upper bound:

Proposition 10.2. $\text{mcr}(K_n) \leq \lfloor \frac{1}{2}(n-5)^2 \rfloor + 4$ for $n \geq 9$.

Proof. We shall exhibit graphs \tilde{K}_n ($n \geq 9$) together with their drawings D_n so that \tilde{K}_n contains K_n as a minor and that $\text{cr}(D_n) = \lfloor \frac{1}{2}(n-5)^2 \rfloor + 4$. Figure 10.2 presents drawings of \tilde{K}_{10} and \tilde{K}_{11} . Different vertex symbols (diamond, circle, triangle, etc.) represent vertices in the same tree T_v , $v \in V(K_n)$, which contracts to the vertex v in the K_n minor. By contracting the thick edges of the graphs in Figure 10.2, we obtain K_{10} and K_{11} , respectively.

The reader shall have no difficulty placing the tree T_{n+1} into D_n in order to obtain D_{n+1} . The tree T_{n+1} crosses precisely each T_v with $7 \leq v \leq n$. To

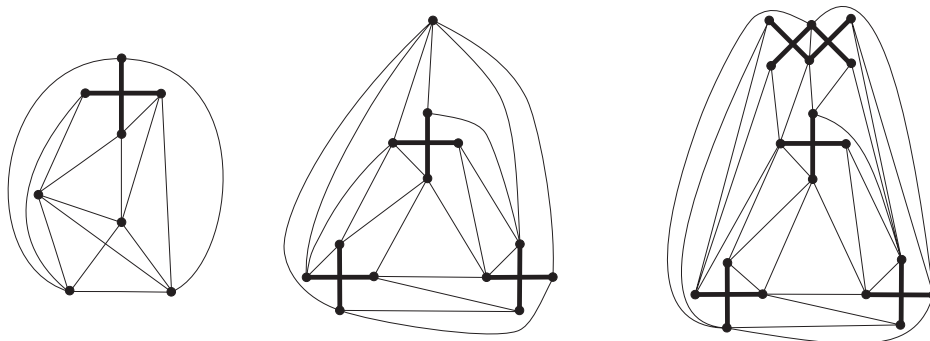

Figure 10.1: Realizing drawings of K_6 , K_7 , and K_8 .

connect T_{n+1} with the trees T_1, \dots, T_6 , we need three new crossings if n is even (T_1 with T_2 , T_3 with T_4 , and T_5 with T_6) and no new crossing if n is odd.

Let c_n denote the number of crossings in the drawing of \tilde{K}_n described above, and let $a_k = c_{2k}$. We have $a_4 = 6$, $a_5 = 14$, $a_6 = 26$ and a recurrence equation,

$$\begin{aligned} a_{k+1} &= c_{2k+2} = c_{2k+1} + (2k - 1 - 6) \\ &= c_{2k} + (2k - 6) + 3 + (2k - 1 - 6) \\ &= c_{2k} + 4k - 8 \\ &= a_k + 4k - 8, \end{aligned}$$

whose solution is $a_k = 2k^2 - 10k + 14$. For even values of n , this yields

$$c_n = \frac{1}{2}((n - 5)^2 + 3)$$

and, for odd values of n ,

$$c_n = \frac{1}{2}(n - 5)^2 + 4.$$

□

Corollary 10.3. *Let Σ be a fixed surface and $c_n = \frac{\text{mcr}(K_n, \Sigma)}{n(n-1)}$ for $n \geq 3$. The sequence $\{c_n\}_{n=3}^{\infty}$ is nondecreasing and, for $\Sigma = \mathbb{S}_0$,*

$$c_{\infty} := \lim_{n \rightarrow \infty} c_n \in \left[\frac{1}{4}, \frac{1}{2}\right].$$

Proof. We first prove the following claim: if $\text{mcr}(K_n, \Sigma) \geq cn(n-1)$, then $\text{mcr}(K_m, \Sigma) \geq cm(m-1)$, for every $m \geq n$.

It suffices to prove this for $m = n+1$. Let \bar{D} be a realizing drawing of K_{n+1} in Σ . Let T_i be the tree in \bar{D} which contracts to the vertex i of K_{n+1} .

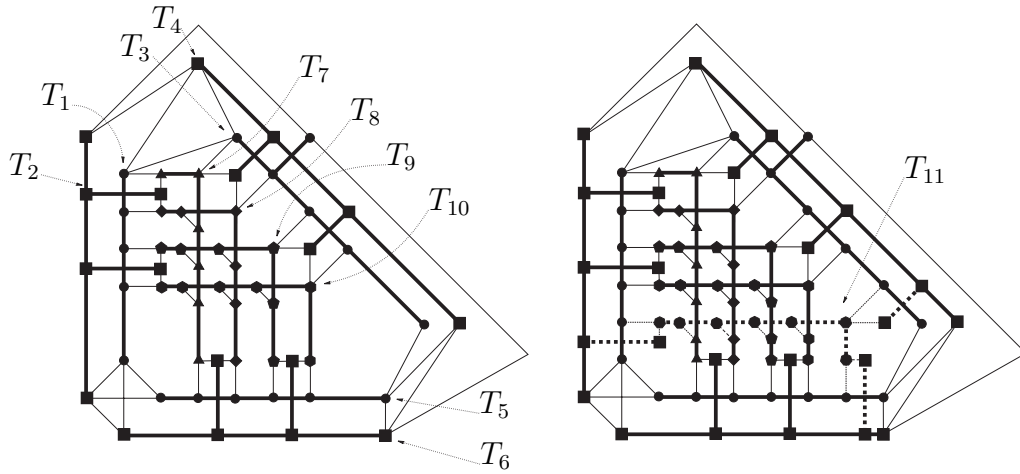

Figure 10.2: Drawings of graphs \tilde{K}_{10} and \tilde{K}_{11} .

If we remove T_i and all incident edges from \bar{D} , we obtain a drawing of a graph with K_n minor. This can be done in $n + 1$ different ways. These $n + 1$ drawings contain at least $(n + 1) \text{mcr}(K_n, \Sigma)$ crossings altogether. We may assume there are no removed edges in \bar{D} , as their number can only increase the number of crossings. Each crossing from \bar{D} then appears in at most $n - 1$ of these drawings. Therefore, $(n - 1) \text{mcr}(K_{n+1}, \Sigma) \geq (n + 1) \text{mcr}(K_n, \Sigma) \geq c(n + 1)n(n - 1)$.

The stated bounds on c_∞ for $\Sigma = \mathbb{S}_0$ follow from Proposition 10.1 and Proposition 10.2. \square

We believe that the minor crossing numbers of complete graphs lie close to the upper bound from Proposition 10.2 and that the following asymptotic holds: $\text{mcr}(K_n) = \frac{1}{2}n^2 + O(n)$.

10.2 Complete bipartite graphs

The nonorientable genus of complete bipartite graphs [85] in combination with Theorem 8.6 establishes the following proposition:

Proposition 10.4. $\text{mcr}(K_{m,n}) \geq \lceil \frac{1}{2}(m - 2)(n - 2) \rceil$ for $3 \leq m \leq n$.

To establish the upper bound, consider a set of graphs $\tilde{K}_{m,n}$. These are constructed in a similar way as their complete analogues \tilde{K}_n . An example is presented in Figure 10.3 (a).

Proposition 10.5. $\text{mcr}(K_{m,n}) \leq (m - 3)(n - 3) + 5$ for $4 \leq m \leq n$.

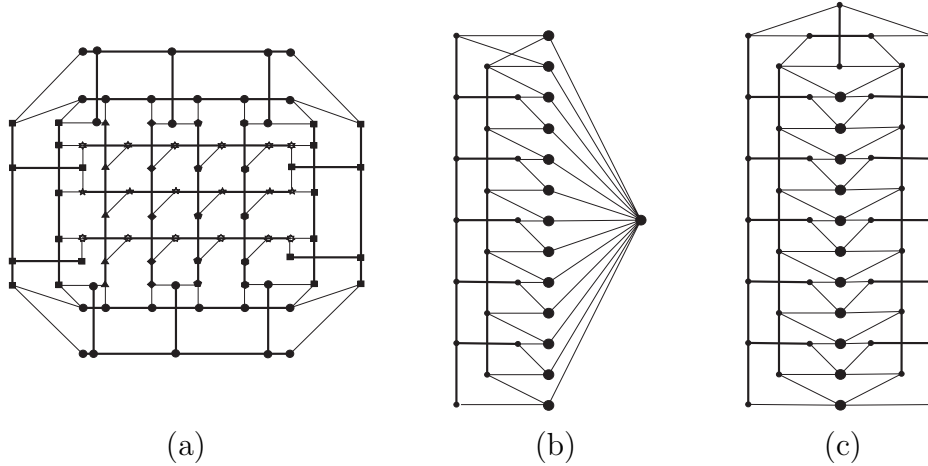

Figure 10.3: (a) A drawing of the graph $\tilde{K}_{8,7}$ with 22 crossings, (b) a realizing drawing of $K_{3,13}$, (c) a realizing drawing of $K_{4,13}$.

Proof. For $4 \leq m \leq n$, let the drawing analogous to the one in Figure 10.3 (a) have $k(m, n)$ crossings. Then,

$$\begin{aligned} k(m, n) &= (m-4)(n-4) + 2 \left\lceil \frac{m-2}{2} \right\rceil + 2 \left\lceil \frac{n-4}{2} \right\rceil \\ &\leq (m-4)(n-4) + (m-2) + 2 + (n-4) + 2 \\ &= (m-3)(n-3) + 5. \end{aligned}$$

□

The lower bound from Proposition 10.4 is sufficient to establish exact values of $\text{mcr}(K_{m,n})$ for small m .

Theorem 10.6. $\text{mcr}(K_{3,n}) = \lceil \frac{n-2}{2} \rceil$ and $\text{mcr}(K_{4,n}) = n-2$ for $n \geq 3$.

Proof. Proposition 10.4 implies $\text{mcr}(K_{3,n}) \geq \lceil \frac{n-2}{2} \rceil$ for $n \geq 3$ and $\text{mcr}(K_{4,n}) \geq n-2$ for $n \geq 4$. Drawings, analogous to those in Figure 10.3 (b) and (c), demonstrate these lower bounds are tight. □

Despite the fact that the lower bound from Proposition 10.4 is attainable for $m = 3, 4$, we believe that the upper bound from Proposition 10.5 lies closer to the actual minor crossing number: $\text{mcr}(K_{m,n}) = mn + O(m+n)$ for $m \geq 5$.

10.3 Hypercubes

Applying Proposition 8.7 to hypercubes yields

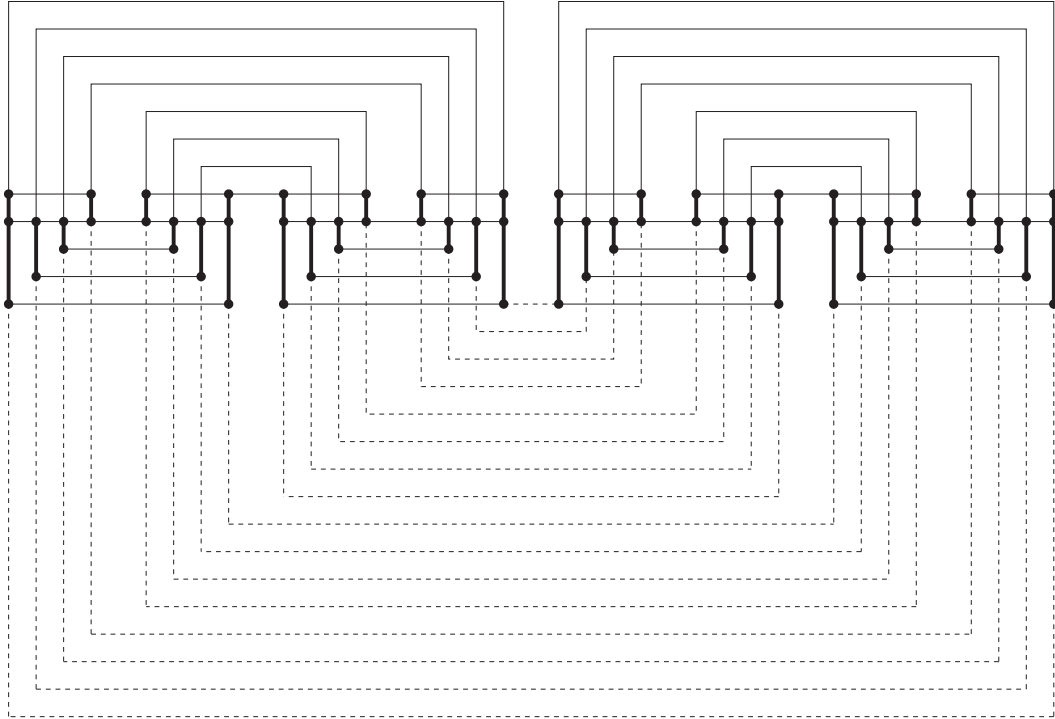

Figure 10.4: A drawing of \tilde{Q}_5 with 64 crossings. Dashed edges correspond to the original edges of a matching between two \tilde{Q}_4 subgraphs.

Proposition 10.7. $\text{mcr}(Q_n) \geq (n - 4)2^{n-2} + 2$ for $n \geq 4$.

Proof. The graph Q_n has $v = 2^n$ vertices, $e = n2^{n-1}$ edges, and girth $r = 4$. Proposition 8.7 implies $\text{mcr}(Q_n) \geq \frac{r-2}{r}e - v + 2 = (n - 4)2^{n-2} + 2$. \square

Combining the best known lower bound for crossing numbers of hypercubes $\text{cr}(Q_n) > 4^n/20 - (n^2 + 1)2^{n-1}$ by Sýkora and Vrto [121] with Corollary 8.4 we can deduce an alternative lower bound. It is stronger than Proposition 10.7 for large values of n :

Proposition 10.8. $\text{mcr}(Q_n) > \frac{1}{n^2} \left(\frac{1}{5} 4^n - 2^{n+1} \right) - 2^{n+1}$ for $n \geq 4$.

Proof. In the graph Q_n , vertices have degree n . Set $\tau = \lfloor \frac{n}{2} \rfloor$. By Corollary 8.4, we have $\text{mcr}(Q_n) \geq \frac{1}{\tau^2} \text{cr}(G) > \frac{1}{n^2} \left(\frac{1}{5} 4^n - 2^{n+1} \right) - 2^{n+1}$. \square

As demonstrated in Figure 10.4, one can obtain a family of graphs \tilde{Q}_n and their drawings D_n with $\Delta(\tilde{Q}_n) = 4$ and \tilde{Q}_n having Q_n as a minor. These, which were inspired by Figures 2 and 3 in [80], establish the following upper bound:

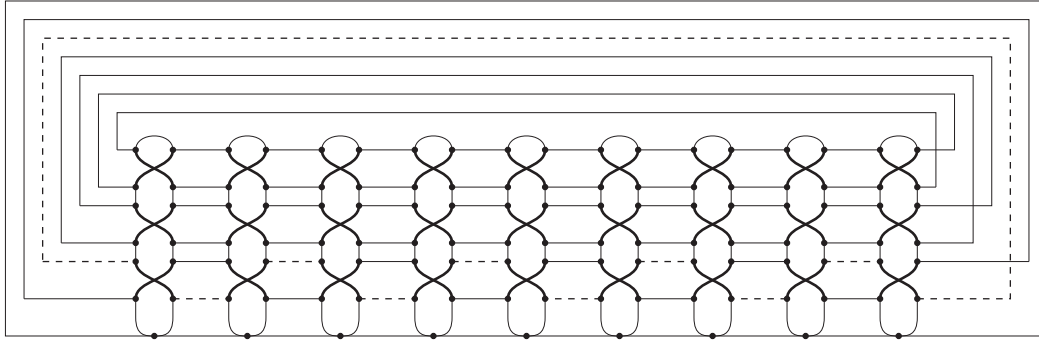

Figure 10.5: A drawing of $G_{7,9}$ with 30 crossings. Dashed edges correspond to the original edges of a cycle corresponding to C_9 .

Proposition 10.9. $\text{mcr}(Q_n) \leq 2 \cdot 4^{n-2} - (n-1)2^{n-1}$ for $n \geq 2$.

Proof. Let a drawing D_n of a graph with Q_n minor be iteratively designed as in Figure 10.4 and let $q(n)$ be its number of crossings. Then $q(3) = 0$ and $q(n) = 2q(n-1) + 2^{n-1}(2^{n-3} - 1)$ for $n \geq 3$. Solving this recurrence relation establishes $q(n) = 2 \cdot 4^{n-2} - (n-1)2^{n-1}$. \square

10.4 Cartesian products of cycles

Combining the results presented in [42] with Theorem 8.3 implies the following:

Proposition 10.10. $\frac{1}{4}(m-2)n \leq \text{mcr}(C_m \square C_n)$ for either $3 \leq m \leq 7$, $n \geq m$, or $m \geq 7$, $n \geq \frac{1}{2}(m+1)(m+2)$.

Figure 10.5 presents a drawing of the graph $G_{7,9}$ whose generalization $G_{m,n}$, $3 \leq m \leq n$ contains a $C_m \square C_n$ minor. It was constructed by Richter, Salazar, and the author [101] and establishes an upper bound for $\text{mcr}(C_m \square C_n)$.

Proposition 10.11. Let $3 \leq m \leq n$. Then, $\text{mcr}(C_m \square C_n) \leq 2 \lfloor \frac{m-1}{2} \rfloor \lfloor \frac{n+1}{2} \rfloor$.

Proof. For odd m , the edges of a (red) cycle corresponding to C_m cross in $\frac{m-1}{2}$ crossings, where one vertex of each cycle is not crossed. For even m , two vertices need not be crossed, thus the number of crossings amounts to $\frac{m-2}{2}$. In general this implies $\lfloor \frac{m-1}{2} \rfloor$ crossings per red cycle. In Figure 10.5, these crossings are between thick edges and they are all the crossings for even n . For odd n , additional $\lfloor \frac{m-1}{2} \rfloor$ crossings appear on the original edges of the (blue) cycles corresponding to C_n . In Figure 10.5, these crossings are between thin edges. \square

Bibliography

- [1] J. Adamsson, The Theory of Arrangements, Dissertation, Carleton University, Ottawa, 2000.
- [2] J. Adamsson, R. B. Richter, Arrangements, circular arrangements, and the crossing number of $C_7 \square C_n$, J. Combin. Theory Ser. B 90 (2004), 21–39.
- [3] M. Aigner, G. M. Ziegler, Proofs from The Book, Springer, Berlin, 2000.
- [4] M. Ajtai, V. Chvátal, M. M. Newborn, E. Szemerédi, Crossing-free subgraphs, in: A. Rosa, G. Sabidussi, J. Turgeon, eds., Theory and Practice of Combinatorics: a Collection of Articles Honoring Anton Kotzig on the Occasion of His Sixtieth Birthday, Ann. Discrete Math. 12, North Holland, Amsterdam, 1983, 9–12.
- [5] M. Anderson, R. B. Richter, P. Rodney, Crossing number of $C_6 \square C_6$, Congr. Numer. 118 (1996), 97–107.
- [6] M. Anderson, R. B. Richter, P. Rodney, Crossing number of $C_7 \square C_7$, Congr. Numer. 119 (1997), 97–117.
- [7] D. Archdeacon, Problems in Topological Graph Theory (1995).
<http://www.emba.uvm.edu/~archdeac/problems/minorcr.htm>
- [8] D. Archdeacon, A Kuratowski theorem for the projective plane, J. Graph Theory 5 (1981), 243–246.
- [9] D. Archdeacon, P. C. Bonnington, Two maps on one surface, J. Graph Theory 36 (2001), 198–216.
- [10] K. Asano, The crossing number of $K_{1,3,n}$ and $K_{2,3,n}$, J. Graph Theory 10 (1986), 1–8.
- [11] J. Balogh, G. Salazar, k -sets, convex quadrilaterals, and the rectilinear crossing number of K_n , to appear in Discrete Comput. Geom. (2006).

- [12] L. W. Beineke, R. D. Ringeisen, On the crossing numbers of products of cycles and graphs of order four, *J. Graph Theory* 4 (1980), 145–155.
- [13] S. N. Bhatt, F. T. Leighton, A framework for solving VLSI graph layout problems, *J. Comput. System Sci.* 28 (1984), 300–343.
- [14] D. Bienstock, N. Dean, Bounds for rectilinear crossing numbers, *J. Graph Theory* 17 (1993), 333–348.
- [15] D. Bienstock, N. Dean, New results on rectilinear crossing numbers and plane embeddings, *J. Graph Theory* 16 (1992), 389–398.
- [16] J. Blažek, M. Koman, A minimal problem concerning complete plane graphs, in: M. Fiedler, ed., *Theory of Graphs and Its Applications*, Academic Press, New York, 1965, 333–338.
- [17] G. Bloom, J. Kennedy, L. Quintas, On crossing numbers and linguistic structures, in: M. Borowiecki, J. W. Kennedy, M. M. Sysło, eds., *Graph Theory Proceedings, Łagów 1981*, Lecture Notes in Math. 1018, Springer, Berlin, 1983, 14–22.
- [18] H. L. Bodlaender, A. Grigoriev, Algorithms for graphs embeddable with few crossings per edge, in: M. Liskiewicz, R. Reischuk, eds., *Fundamentals of Computation Theory*, Lecture Notes in Comput. Sci. 3623, Springer, Berlin, 2005, 378–387.
- [19] D. Bokal, Technical details regarding infinite families of crossing-critical graphs with prescribed average degree and crossing number, *Mathematica™ notebook* (2006),
<http://lp.fmf.uni-lj.si/~drago/construction3.6.nb> or
<http://lp.fmf.uni-lj.si/~drago/construction3.6.pdf>.
- [20] D. Bokal, G. Fijavž, B. Mohar, The minor crossing number, *SIAM J. Disc. Math.*, to appear (2006).
- [21] A. Brodsky, S. Durocher, E. Gethner, Toward the rectilinear crossing number of K_n : new drawings, upper bounds and asymptotics, *Discrete Math.* 262 (2003), 59–77.
- [22] C. Buchheim, D. Ebner, M. Jünger, G. W. Klau, P. Mutzel, R. Weiskircher, Exact crossing minimization, in: P. Healy, N. S. Nikolov, eds., *Graph Drawing: 13th International Symposium*, Lecture Notes in Comput. Sci. 3843, Springer, Berlin, 2006, 386–396.

-
- [23] F. M. Chockallingam, VLSI layout for the star connected cycles, Tech. Report, University of Nevada, Reno, 1996.
- [24] C. Chojnacki, Über wesentlich unplättbare Kurven im dreidimensionalen Raume, *Fund. Math.* 23 (1934), 135–142.
- [25] F. Chung, S. T. Yau, A near optimal algorithm for edge separators, in: F. T. Leighton, M. Goodrich, eds., *Proceedings of the 26th Annual ACM Symposium on Theory of Computing*, ACM Press, New York, 1994, 1–8.
- [26] A. M. Dean, R. B. Richter, The crossing number of $C_4 \square C_4$, *J. Graph Theory* 19 (1995), 125–129.
- [27] R. Diestel, *Graph Theory*, Graduate Texts in Mathematics, vol. 173, Springer, New York, 2000.
- [28] H. E. Dudeney, *Amusements in Mathematics* (1917), The Gutenberg Project, 2005, <http://www.gutenberg.org/etext/16713>.
- [29] R. Eckler, *Dictionary eodermdromes*, Word Ways, 1980.
- [30] R. B. Eggleton, R. K. Guy, The crossing number of the n -cube, *Notices Amer. Math. Soc.* 17 (1970), 757.
- [31] G. Elekes, On the number of sums and products, *Acta Arith.* 81 (1997), 365–367.
- [32] G. Elekes, Sums versus products in number theory, algebra and Erdős geometry, in: G. Halász, L. Lovász, M. Simonovits, V. T. Sós, eds., *Paul Erdős and His Mathematics II*, Bolyai Soc. Math. Stud. 11, Springer, Berlin, 2002, 241–290.
- [33] G. Elekes, M. B. Nathanson, I. Z. Ruzsa, Convexity and sumsets, *J. Number Theory* 83 (1999), 194–201.
- [34] P. Erdős, R. K. Guy, Crossing number problems, *Amer. Math. Monthly* 80 (1973), 52–58.
- [35] G. Exoo, F. Harary, J. Kabell, The crossing numbers of some generalized Petersen graphs, *Math. Scand.* 48 (1981), 184–188.
- [36] L. Faria, C. M. H. de Figueiredo, On Eggleton and Guy conjectured upper bound for the crossing number of the n -cube, *Math. Slovaca* 50 (2000), 271–287.

- [37] L. Faria, C. M. H. de Figueiredo, O. Sýkora, I. Vrto, An improved upper bound on the crossing number of the hypercube, in: H. L. Bodlaender, ed., *Graph-theoretic Concepts in Computer Science*, Lecture Notes in Comput. Sci. 2880, Springer, Berlin, 2003, 230–236.
- [38] G. Fijavž, *Grafovski minorji in povezanost*, Dissertation, University of Ljubljana, 2001.
- [39] S. Fiorini, On the crossing number of generalized Petersen graphs, in: A. Barlotti, M. Biliotti, A. Cossu, G. Korchmaros, G. Tallini., eds., *Combinatorics '84: Proceedings of the International Conference on Finite Geometries and Combinatorial Structures*, Ann. Discrete Math. 30, North-Holland, Amsterdam, 1986, 225–242.
- [40] M. R. Garey, D. S. Johnson, Crossing number is NP-complete, *SIAM J. Algebraic and Discrete Methods* 4 (1983), 312–316.
- [41] J. F. Geelen, R. B. Richter, G. Salazar, Embedding grids on surfaces, *European J. Combin.* 25 (2004), 785–792.
- [42] L. Y. Glebsky, G. Salazar, The crossing number of $C_m \square C_n$ is as conjectured for $n \geq m(m+1)$, *J. Graph Theory* 47 (2004), 53–72.
- [43] H. H. Glover, J. P. Huneke, Cubic irreducible graphs for the projective plane, *Discrete Math.* 13 (1975), 341–355.
- [44] H. H. Glover, J. P. Huneke, C.-S. Wang, 103 graphs that are irreducible for the projective plane, *J. Combin. Theory Ser. B* 27 (1979), 332–370.
- [45] M. Grohe, Computing crossing numbers in quadratic time, *J. Comput. System Sci.* 68 (2004), 285–302.
- [46] R. K. Guy, Latest results on crossing numbers, in: M. Capobianco, J. B. Frechen, M. Krolík, eds., *Recent Trends in Graph Theory*, Lecture Notes in Math. 186, Springer, Berlin, 1971, 143–156.
- [47] R. K. Guy, The decline and fall of Zarankiewicz's theorem, in: F. Harary, ed., *Proof Techniques in Graph Theory*, Academic Press, New York, 1969, 63–69.
- [48] R. K. Guy, A. Hill, The crossing number of the complement of a circuit, *Disc. Math.* 5 (1973), 335–344.
- [49] R. K. Guy, T. A. Jenkyns, The toroidal crossing number of $K_{m,n}$, *J. Combin. Theory* 6 (1969), 235–250.

-
- [50] R. K. Guy, T. A. Jenkyns, J. Schaer, The toroidal crossing number of the complete graph, *J. Combin. Theory* 4 (1968), 376–390.
- [51] F. Harary, P. C. Kainen, A. J. Schwenk, Toroidal graphs with arbitrarily high crossing numbers, *Nanta Math.* 6 (1973), 58–67.
- [52] A. Hatcher, *Algebraic Topology*, Cambridge University Press, New York, 2002.
- [53] P. Hliněný, Crossing-critical graphs and path-width, in: P. Mutzel, M. Jünger, S. Leipert, eds., *Proc. 9th Intl. Symposium on Graph Drawing*, *Lecture Notes in Comput. Sci.* 2265, Springer, Berlin, 2001, 102–114.
- [54] P. Hliněný, Crossing-critical graphs have bounded path-width, *J. Combin. Theory Ser. B* 88 (2003), 347–367.
- [55] P. Hliněný, Crossing number is hard for cubic graphs, in: J. Fiala, V. Koubek, J. Kratochvíl, eds., *Math Foundations of Computer Science 2004*, *Lecture Notes in Comput. Sci.* 3153, Springer, Berlin, 2004, 772–782.
- [56] F. Jaeger, Tait’s theorem for graphs with crossing number at most one, *Ars Combin.* 9 (1980), 283–287.
- [57] S. Jendrol’, M. Ščerbová, On the crossing numbers of $S_m \square P_n$ and $S_m \square C_n$, *Časopis pro pěstování matematiky* 107 (1982), 225–230.
- [58] H. A. Juarez, G. Salazar, Drawings of $C_m \square C_n$ with one disjoint family II, *J. Combin. Theory Ser. B* 82 (2001), 161–165.
- [59] M. Juvan, B. Mohar, An algorithm for embedding graphs in the torus, submitted.
- [60] P. C. Kainen, A lower bound for crossing number of graphs with applications to K_n , $K_{p,q}$, and $Q(d)$, *J. Combin. Theory Ser. B* 12 (1972), 287–298.
- [61] P. C. Kainen, On the stable crossing number of cubes, *Proc. Amer. Math. Soc.* 36 (1972), 55–62.
- [62] P. C. Kainen, A. T. White, On stable crossing numbers, *J. Graph Theory* 2 (1978), 181–187.
- [63] J. W. Kennedy, P. J. Wexler, G. S. Bloom, Linguistic complexity and minimal eodermdromes, *Linguistics* 18 (1980), 3–16.

-
- [64] S. Klavžar, B. Mohar, Crossing numbers of Sierpiński-like graphs, to appear in *J. Graph Theory*.
- [65] D. J. Kleitman, The crossing number of $K_{5,n}$, *J. Combin. Theory Ser. B* 9 (1971), 315–323.
- [66] M. Klešč, On the crossing numbers of Cartesian products of stars and paths or cycles, *Math. Slovaca* 41 (1991), 113–120.
- [67] M. Klešč, The crossing numbers of Cartesian products of paths with 5-vertex graphs, *Discrete Math.* 233 (2001), 353–359.
- [68] M. Klešč, The crossing number of $K_{2,3} \square C_3$, *Discrete Math.* 251 (2002), 109–117.
- [69] M. Klešč, The crossing number of $K_{2,3} \square P_n$ and $K_{2,3} \square S_n$, *Tatra Mt. Math. Publ.* 9 (1996), 51–56.
- [70] M. Klešč, The crossing numbers of products of paths and stars with 4-vertex graphs, *J. Graph Theory* 18 (1994), 605–614.
- [71] M. Klešč, R. B. Richter, I. Stobert, The crossing number of $C_5 \square C_n$, *J. Graph Theory* 22 (1996), 239–243.
- [72] M. Kochol, Construction of crossing-critical graphs, *Discrete Math.* 66 (1987), 311–313.
- [73] V. R. Kulli, D. G. Akka, L. W. Beineke, On line graphs with crossing number 1, *J. Graph Theory* 3 (1979), 87–90.
- [74] K. Kuratowski, Sur le problème des courbes gauches en topologie, *Fund. Math.* 15 (1930), 271–283.
- [75] J. Leños, G. Salazar, On the additivity of crossing numbers of graphs, preprint.
- [76] F. T. Leighton, *Complexity Issues in VLSI*, MIT Press, Cambridge, 1983.
- [77] F. T. Leighton, New lower bound techniques for VLSI, *Math. Systems Theory* 17 (1984), 47–70.
- [78] R. Lipton, R. Tarjan, A separator theorem for planar graphs, *SIAM J. Appl. Math.* 36 (1979), 177–189.
- [79] D. Ma, H. Ren, J. Lu, The crossing number of the circular graph $C(2m + 2, m)$, *Discrete Math.* 304 (2005), 88–93.

-
- [80] T. Madej, Bounds for the crossing number of the N -cube, *J. Graph Theory* 15 (1991), 81–97.
- [81] D. McQuillan, R. B. Richter, On 3-regular graphs having crossing number at least 2, *J. Graph Theory* 18 (1994), 831–893.
- [82] D. McQuillan, R. B. Richter, On the crossing numbers of certain generalized Petersen graphs, *Disc. Math.* 104 (1992), 311–320.
- [83] B. Mohar, Obstructions for the disk and cylinder embedding extension problems, *Combin. Probab. Comput.* 3 (1994), 375–406.
- [84] B. Mohar, Projective planarity in linear time, *J. Algorithms* 15 (1993), 482–502.
- [85] B. Mohar, C. Thomassen, *Graphs on Surfaces*, Johns Hopkins University Press, Baltimore, 2001.
- [86] E. G. Moreno, G. Salazar, Bounding the crossing number of a graph in terms of the crossing number of a minor with small maximum degree, *J. Graph Theory* 36 (2001), 168–173.
- [87] B. Oporowski, Large four-connected nonplanar graphs, draft.
- [88] J. Pach, R. Radoičić, G. Tardos, G. Tóth, Improving the crossing lemma by finding more crossings in sparse graphs, in: J. Snoeyink, J. D. Boissonnat, eds., *Proceedings of the Twentieth Annual Symposium on Computational Geometry*, ACM Press, New York, 2004, 68–75.
- [89] J. Pach, F. Shahrokhi, M. Szegedy, Applications of the crossing number, *Algorithmica* 16 (1996), 111–117.
- [90] J. Pach, J. Spencer, G. Tóth, New Bounds on Crossing Numbers, *Discrete Comput. Geom.* 24 (2000), 623–644.
- [91] J. Pach, G. Tóth, Graphs drawn with few crossings per edge, *Combinatorica* 17 (1997), 427–439.
- [92] J. Pach, G. Tóth, Which crossing number is it anyway?, *J. Combin. Theory Ser. B* 80 (2000), 225–246.
- [93] S. Pan, R. B. Richter, The crossing number of K_{11} is 100, submitted.

-
- [94] M. J. Pelsmajer, M. Schaefer, D. Štefankovič, Odd Crossing Number Is Not Crossing Number, in: P. Healy, N. S. Nikolov, eds., Graph Drawing: 13th International Symposium, Lecture Notes in Comput. Sci. 3843, Springer, Berlin, 2006, 386–396.
- [95] B. Pinontoan, R. B. Richter, Crossing numbers of sequences of graphs I: general tiles, Australas. J. Combin. 30 (2004), 197–207.
- [96] B. Pinontoan, R. B. Richter, Crossing numbers of sequences of graphs II: planar tiles, J. Graph Theory 42 (2003), 332–342.
- [97] G. Pica, T. Pisanski, A. G. S. Ventre, Cartesian products of graphs and their crossing numbers, in: A. Barlotti, M. Biliotti, A. Cossu, G. Korchmaros, G. Tallini., eds., Combinatorics '84: Proceedings of the International Conference on Finite Geometries and Combinatorial Structures, Ann. Discrete Math. 30, North-Holland, Amsterdam, 1986, 339–346.
- [98] R. B. Richter, Cubic graphs with crossing number two, J. Graph Theory 12 (1988), 363–374.
- [99] R. B. Richter, Subgraphs with crossing number two, Congr. Numer. 60 (1987), 169–180.
- [100] R. B. Richter, G. Salazar, A survey of good crossing number theorems and questions, preprint.
- [101] R. B. Richter, G. Salazar, personal communication, 2006.
- [102] R. B. Richter, G. Salazar, The crossing number of $C_6 \square C_n$, Australas. J. Combin. 23 (2001), 135–143.
- [103] R. B. Richter, G. Salazar, The crossing number of $P(N, 3)$, Graphs Combin. 18 (2002), 381–394.
- [104] R. B. Richter, J. Širáň, The crossing number of $K_{3,n}$ in a surface, J. Graph Theory 21 (1996), 51–54.
- [105] R. B. Richter, C. Thomassen, Minimal graphs with crossing number at least k , J. Combin. Theory Ser. B 58 (1993), 217–224.
- [106] R. B. Richter, C. Thomassen, Intersections of curve systems and the crossing number of $C_5 \square C_5$, Discrete Comput. Geom. 13 (1995), 149–159.

- [107] R. B. Richter, C. Thomassen, Relations between crossing numbers of complete and complete bipartite graphs, *Amer. Math. Monthly* 104 (1997), 131–197.
- [108] R. D. Ringeisen, L. W. Beineke, The crossing number of $C_3 \square C_n$, *J. Combin. Theory Ser. B* 24 (1978), 134–136.
- [109] N. Robertson, P. Seymour, Excluding a graph with one crossing, *Contemp. Math.* 147 (1993), 669–675.
- [110] G. Salazar, Drawings of $C_m \square C_n$ with one disjoint family, *J. Combin. Theory Ser. B* 76 (1999), 129–135.
- [111] G. Salazar, Infinite families of crossing-critical graphs with given average degree, *Discrete Math.* 271 (2003), 343–350.
- [112] G. Salazar, Nearly-light cycles in embedded graphs and in crossing-critical graphs, preprint.
- [113] G. Salazar, On a crossing number result of Richter and Thomassen, *J. Combin. Theory Ser. B* 79 (2000), 98–99.
- [114] G. Salazar, On the crossing numbers of loop networks and generalized Petersen graphs, *Discrete Math.* 302 (2005), 243–253.
- [115] E. R. Scheinerman, H. S. Wilf, The rectilinear crossing number of a complete graph and Sylvester’s four point problem of geometric probability, *Amer. Math. Monthly* 101 (1994), 939–943.
- [116] F. Sharokhi, O. Sýkora, L. A. Székely, I. Vrto, Crossing numbers: bounds and applications, in: I. Bárány, K. Boroczky, eds., *Intuitive Geometry*, Bolyai Soc. Math. Stud. 6, Springer, Berlin, 1997, 179–206.
- [117] F. Sharokhi, O. Sýkora, L. A. Székely, I. Vrto, The crossing number of a graph on a compact 2-manifold, *Adv. Math.* 123 (1996), 105–119.
- [118] F. Sharokhi, O. Sýkora, L. A. Székely, I. Vrto, Intersection of curves and crossing number of $C_m \square C_n$ on surfaces, *Discrete Comput. Geom.* 19 (1998), 237–247.
- [119] F. Shahrokhi, L. A. Székely, On canonical concurrent flows, crossing number and graph expansion, *Combin. Probab. Comput.* 3 (1994), 523–543.

- [120] O. Sýkora, I. Vrto, Edge separators for graphs of bounded genus with applications, *Theor. Comput. Sci.* 112 (1993), 419–429.
- [121] O. Sýkora, I. Vrto, On crossing numbers of hypercubes and cube connected cycles, *BIT* 33 (1993), 232–237.
- [122] O. Sýkora, I. Vrto, On VLSI layouts of the star graph and related networks, *Integration, the VLSI Journal* 17 (1994), 83–94.
- [123] J. J. Sylvester, On a special class of questions on the theory of probabilities, *Birmingham British Association Report* 8 (1865).
- [124] L. A. Székely, A successful concept for measuring non-planarity of graphs: the crossing number, *Discrete Math.* 276 (2004), 331–352.
- [125] L. A. Székely, Crossing numbers and hard Erdős problems in discrete geometry, *Combin. Probab. Comput.* 6 (1997), 353–358.
- [126] E. Szemerédi, W. T. Trotter, Extremal problems in discrete geometry, *Combinatorica* 3 (1983), 381–392.
- [127] J. Širáň, Crossing-critical edges and Kuratowski subgraphs of a graph, *J. Combin. Theory Ser. B* 35 (1983), 83–92.
- [128] J. Širáň, Infinite families of crossing-critical graphs with a given crossing number, *Discrete Math.* 48 (1984), 129–132.
- [129] R. Torrens, Ultrasonics: remote control and intruder detector, 4QD-TEC, 2005, <http://www.4qdtec.com/ultra.html>.
- [130] P. Turán, A note of welcome, *J. Graph Theory* 1 (1977), 7–9.
- [131] W. T. Tutte, Toward a theory of crossing numbers, *J. Combin. Theory* 8 (1970), 45–53.
- [132] I. Vrto, Crossing number of graphs: a bibliography.
<ftp://ftp.ifi.savba.sk/pub/imrich/crobib.pdf>
- [133] A. T. White, L. W. Beineke, Topological Graph Theory, in: L. W. Beineke, R. J. Wilson, eds., *Selected Topics in Graph Theory*, Academic Press, New York, 1978, 15–50.
- [134] D. R. Woodall, Cyclic-order graphs and Zarankiewicz’s crossing-number conjecture, *J. Graph Theory* 17 (1993), 657–671.

-
- [135] Y. Yuansheng, L. Xiaohui, L. Jianguo, H. Xin, The crossing number of $C(n, \{1, 3\})$, *Discrete Math.* 289 (2004), 107–118.
- [136] Y. Yuansheng, L. Xiaohui, L. Jianguo, H. Xin, The crossing number of $C(mk, \{1, k\})$, *Graphs Combin.* 21 (2005), 89–96.
- [137] K. Zarankiewicz, On a problem of P. Turán concerning graphs, *Fund. Math.* 41 (1954), 137–145.

Index of Terms

- active vertex, 35
- adjacent
 - edges, 5
 - faces, 9
 - vertices, 5
- aligned
 - family, 44, 58
 - pair, 44
- annihilating a crosscap, 86
- apex, 40, 65
- area, 23
- augmented
 - embedding, 89
 - graph, 87, 89
- average degree, 22, 26, 56, 60, 63
- axis, 51

- binary tree, 23
- bisection width, 18
- block, 6, 7, 83
- bridge gadget, 52
- bundle, 32, 50, 69
 - coherent, 32–35, 38
 - splitting of, 32–34, 50, 51

- cap, 65
- Cartesian product, 7, 20, 68, 96
 - capped, 65, 66
- chromatic
 - index, 7, 59
 - number, 7
- circuit, 23, 27
- clone, 50

- coherent
 - bundles, 32–35, 38
 - clone gadgets, 50
 - gadgets, 43
 - pairs, 44
 - sets, 44
- coloring, 7, 59
- compatible
 - sequence, 39
 - tiles, 39
- complement
 - of a graph, 7
 - of a tile, 41
- complete
 - bipartite graph, 8, 59, 93
 - graph, 7, 91
- component, 6
- congestion, 17
- connected, 23, 83
 - graph, 6
 - tile, 41
 - vertices, 6
- contracted edge, 8, 76, 79, 80
- cover, vertex, 6, 37
- critical sequence, 43, 45, 55, 57
- crosscap, 9, 82
- crossed fence, 23
- crossing, 10
 - edge-edge, 77
 - edge-vertex, 77
 - vertex-vertex, 77
- Crossing Lemma, 15, 16, 24

- crossing number, 10
 - major, 76
 - minor, 27, 76
 - odd, 15
 - pair, 15
 - rectilinear, 11, 25
 - tile, 39
- crossing-critical
 - edge, 21
 - graph, 10, 21, 35, 43, 60
- cubic graph, 5, 59, 77
- cut, 40, 42, 45
- cutedge, 6
- cutvertex, 6
- cycle, 67, 96
- cyclically-compatible
 - sequence, 39, 42
 - tile, 39
- cyclization, 40, 42, 45, 55, 57
- decomposition
 - of a crossing-critical graph, 23, 38
 - of a surface, 83
- degenerate
 - drawing, 86, 87
 - tile, 43, 55, 57
- degree
 - average, 22, 26, 56, 60, 63
 - maximum, 5, 79, 81
 - minimum, 5, 22
 - of a clone gadget, 50
 - of a vertex, 5
- digon, 89
- disjoint union, 7
- distance, 24
- distant edge, 32
- dominating vertex, 6, 65, 66
- drawing, 10
 - degenerate, 86, 87
 - graph of, 10, 89
 - normal, 10
 - optimum, 10
 - realizing, 76, 82
 - rectilinear, 10
 - tile, 39
- edge, 5
 - congestion, 17
 - contracted, 8, 76, 79, 80
 - crossing-critical, 21
 - distant, 32
 - near, 32
 - original, 8, 76
 - removed, 8, 76
 - rotation, 9, 31
 - unbalanced, 65
- edge-coloring, 7, 59
- edge-connected graph, 6, 23
- embedding
 - augmented, 89
 - into a graph, 17
 - into a surface, 9, 87
 - method, 17
- empty graph, 8, 65
- endvertex, 5
- eodermdrome, 25
- equivalent sequences, 40
- Euler
 - characteristic, 9
 - Formula, 9, 82, 89, 90
 - genus, 9, 10, 87, 89
- extending
 - family, 45
 - of a pair, 45
- face
 - infinite, 10
 - of a drawing, 10
 - of an embedding, 9
- facial walk, 9
- family

- aligned, 44, 58
- extending, 45
- infinite, 60
- propagating, 45, 57
- saturating, 45
- twisted, 44, 57
- fence, crossed, 23
- flip, 40
- forbidden minor, 8, 85
- forest, 6
- function, zip, 31
- gadget, 43
 - bridge, 52
 - clone, 50
 - coherent, 43
 - wheel, 51, 69
- genus, 82
 - Euler, 9, 10, 87
 - of a graph, 9
 - of a surface, 9
- girth, 6, 82
- graph, 5
 - augmented, 87, 89
 - complete, 7, 91
 - bipartite, 8, 59, 93
 - crossing-critical, 10, 21, 35, 43, 60
 - cubic, 5, 59, 77
 - edge-connected, 6, 23
 - empty, 8, 65
 - homeomorphic, 7
 - isomorphic, 6
 - line, 7, 14
 - of a drawing, 10, 89
 - Petersen, 59, 85
 - realizing, 27, 76, 77
 - regular, 5, 22, 63
 - simple, 5
 - subcubic, 5
- handle, 9, 82
- homeomorphic graph, 7
- homogeneous neighborhood, 35
- homomorphism, 6
- hub, 51
- hypercube, 8, 19, 94
- incidence, 24
- incident
 - edge and face, 9
 - vertex and edge, 5
 - vertex and face, 9
- index, chromatic, 7, 59
- induced subgraph, 6
- infinite
 - face, 10
 - family, 60
 - point, 10
- internal vertex, 32, 51
- intersection, 7
- intertwined pair, 52
- inverted tile, 40, 56
- isomorphic graph, 6
- isomorphism, 6
- join
 - of a sequence, 40
 - of graphs, 7
 - of tiles, 40
- Klein bottle, 9, 88
- left
 - in a tile, 45
 - inverted tile, 40
 - wall, 39
- length, 6
- line, 24
 - graph, 7, 14
- loop, 5
- major crossing number, 76
- maximum degree, 5, 79, 81

- minimum degree, 5, 22
- minor, 8, 79, 81
 - crossing number, 27, 76
 - forbidden, 8, 85
- minor-closed property, 8, 76
- multigraph, 5
- multiplicity neighborhood, 5, 31

- near edge, 32
- neighbor, 5
- neighborhood, 5
 - homogeneous, 35
 - multiplicity, 5, 31
- nonorientable surface, 9
- normal drawing, 10
- number
 - chromatic, 7
 - crossing, 10

- odd crossing number, 15
- optimum drawing, 10
- orientable surface, 9
- orientably degenerate drawing, 86
- orienting system, 86
- original edge, 8, 76

- pair
 - aligned, 44
 - coherent, 44
 - crossing number, 15
 - intertwined, 52
 - split, 52
 - twisted, 44, 57
- path, 6, 66, 69, 70
 - traversing, 44, 45
- path-width, 23
- perfect tile, 41, 42
- Petersen graph, 59, 85
- planar tile, 41
- point, 24
 - infinite, 10
 - random, 25

- product
 - capped Cartesian, 65, 66
 - Cartesian, 7, 20, 68, 96
 - zip, 26, 31, 59, 60, 65
- projective plane, 9, 85
- propagating family, 45, 57
- property, minor-closed, 8, 76

- realizing
 - drawing, 76, 82
 - graph, 27, 76, 77
- rectilinear
 - crossing number, 11, 25
 - drawing, 10
- regular graph, 5, 22, 63
- removed edge, 8, 76
- reversed
 - sequence, 40
 - tile, 40
- right
 - in a tile, 45
 - inverted tile, 40
 - wall, 39
- rim, 51
- rotation
 - of edges, 9, 31
 - of vertices, 9, 65

- saturating family, 45
- semiactive vertex, 35
- separator, 6
- sequence
 - compatible, 39
 - critical, 43, 45, 55, 57
 - cyclically-compatible, 39, 42
 - equivalent, 40
 - reversed, 40
 - staircase, 55
- shift, 40
- simple graph, 5
- sink, 32, 51

- source, 32, 51
- spanned subgraph, 6
- spanning subgraph, 6
- sphere, 9, 83
- split pair, 52
- splitting a bundle, 32–34, 50, 51
- spoke, 51, 69
- staircase
 - sequence, 55
 - strip, 26, 46, 47, 55
 - tile, 55
- star, 8, 68
- subcubic graph, 5
- subdivision, 7, 69
- subgraph, 6
 - induced, 6
 - spanned, 6
 - spanning, 6
- surface, 9
 - nonorientable, 9
 - orientable, 9
- suspension, 65, 67
 - of a graph, 65
 - of a tile, 40
- system, 86
- tile, 26, 39
 - compatible, 39
 - connected, 41
 - crossing number, 39
 - cyclically-compatible, 39
 - degenerate, 43, 55, 57
 - drawing, 39
 - in a graph, 41
 - inverted, 40, 56
 - perfect, 41, 42
 - planar, 41
 - reversed, 40
 - staircase, 55
- torus, 9
- touching, 10
- transformation, $Y\Delta$, ΔY , 7, 85
- traversing path, 44, 45
- tree, 6, 65, 68, 72
 - binary, 23
- tree-width, 23
- triangle, 7
- tripod, 52
- twist, 40
- twisted
 - family, 44, 57
 - pair, 44, 57
 - staircase strip, 46, 55
- unbalanced edge, 65
- union, disjoint, 7
- vertex, 5
 - active, 35
 - congestion, 17
 - cover, 6, 37
 - dominating, 6, 65, 66
 - internal, 32, 51
 - rotation, 9, 65
 - semiactive, 35
- VLSI, 15, 23, 26
- walk, facial, 9
- wall, 39
- weight, 80
- wheel, 8, 69
 - gadget, 51, 69
 - in a graph, 51
- width
 - bisection, 18
 - path-, 23
 - tree-, 23
- zip
 - function, 31
 - product, 26, 31, 59, 60, 65

Index of Symbols

$D_1 \odot_\sigma D_2$, 31	Q_d , 8
$\check{E}(B)$, 32	S_n , 8
$E(G)$, 5	T_v , 8, 77
$E(v, v')$, 50	$V(G)$, 5
$F(k)$, 85	W_n , 8
$F(k, \Sigma)$, 85	$\deg_G(v)$, 5
\tilde{G} , 76	$\text{eg}(G)$, 10
$G - e$, 6	$\text{eg}(\Sigma)$, 9
$G - v$, 6	$g(G)$, 9
$G[F]$, 6	$\tilde{g}(G)$, 9
$G[U]$, 6	$\ell(v)$, 65
$G \leq H$, 6	$\text{mcr}(G)$, 76
$G \leq_m H$, 8	$\text{mcr}(G, \Sigma)$, 76
G_D , 10	$r(G)$, 6
G^c , 7	$\text{rcr}(G)$, 11
$G^{(i)}$, 65	uP , 6
$G^{\mathcal{S}}$, 37	uPv , 6
$G_1 + G_2$, 7	$\mathcal{A}(G)$, 35
$G_1 \cap G_2$, 7	$\mathcal{S}(G)$, 35
$G_1 \cup G_2$, 7	\mathbb{N}_g , 9
$G_1 \odot_\sigma G_2$, 31	\mathbb{S}_g , 9
$G_1 \odot_{v_1 \odot v_2} G_2$, 31	$\Delta(G)$, 5
$G_1 \square G_2$, 7	Σ , 9
$G_1 \square_L G_2$, 65	Σ/γ , 86
$G_1 \hat{\square} G_2$, 65	$\Omega(k, \Sigma)$, 76
K_n , 7	$\beta(G)$, 65
\bar{K}_n , 8	$\delta(G)$, 5
$K_{m,n}$, 8	$\chi(G)$, 7
$L(G)$, 7	$\chi'(G)$, 7
$\text{Mcr}(G, \Sigma)$, 76	$\chi(\Sigma)$, 9
$N_G(v)$, 5	$\chi_L(v)$, 65
$N_G^*(v)$, 5	$\omega(k)$, 85
P_m , 6	$\omega(k, \Sigma)$, 76, 85
Pu , 6	

Razširjeni povzetek

Definicije

V tem razdelku predstavimo osnovne pojme teorije prekriznega števila. Pri tem predpostavimo, da je bralec seznanjen s terminologijo teorije grafov in topologije. Viri za seznanjanje s temi temami so [27, 38, 52].

Z izrazom *graf* označimo multigraf brez zank. Zanke namreč pri študiju prekriznega števila niso pomembne, saj lahko v vsako risbo grafa dodamo poljubno mnogo zank, ne da bi povečali število križišč. Kadar želimo poudariti, da graf nima večkratnih povezav, uporabimo izraz *enostaven graf*. Od standardne terminologije nekoliko odstopa le pojem *okolice vozlišča* v grafu. Z $N_G(v)$ označimo običajno okolico vozlišča v v grafu G , t. j. množico vseh sosedov v . Z $N_G^*(v)$ pa označimo *multiokolico* vozlišča v , t. j. multimnožico, v kateri se vsak sosed vozlišča v pojavi tolikokrat, kot je večkratnost njegove povezave z v .

Risba grafa G na ploskvi Σ je par preslikav $D = (\varphi, \varepsilon)$, od katerih je $\varphi : V(G) \rightarrow \Sigma$ injektivna vložitev vozlišč grafa na ploskev, $\varepsilon : E(G) \times [0, 1] \rightarrow \Sigma$ pa slika povezave grafa v enostavne (poligonalne) krivulje na Σ z upoštevanjem slik krajišč povezav. Tako velja $\varepsilon(uv, 0) = \varphi(u)$, $\varepsilon(uv, 1) = \varphi(v)$ in nobena slika vozlišča ne leži v notranjosti slik povezav, $\varepsilon(E(G) \times (0, 1)) \cap \varphi(V(G)) = \emptyset$.

Naj bo $D = (\varphi, \varepsilon)$ risba grafa G na ploskvi Σ . Povezane komponente $\Sigma \setminus \varepsilon(E(G) \times [0, 1])$ imenujemo *lica* risbe D .

Naj bo x slika vozlišča v na risbi D na ploskvi Σ in naj bo U taka okolica x , da je $\varepsilon(E \times [0, 1]) \cap U$ homeomorfna množici intervalov, spojenih v x . Naj bo $B \subseteq U$ okolica x , homeomorfna disku, za katero velja $|\partial B \cap \varepsilon(E \times [0, 1])| = \deg_G(v)$. Vsaka točka tega preseka ustreza eni povezavi, sosednji z v , in njihovo zaporedje na ∂B določa ciklično permutacijo povezav, s tem pa tudi vozlišč, sosednjih z v . Tej permutaciji rečemo *ciklična rotacija* povezav ali vozlišč okrog v na risbi D .

Naj bosta e in f dve poljubni povezavi v G s slikama r in s na Σ . Predpostavimo, da $x \in r \cap s$ ni slika vozlišča iz G . Naj bo U taka okolica x v Σ , da za vsako okolico $B \subseteq U$ točke x , homeomorfno disku, velja $B \cap r \cap s = \{x\}$ in

$|\partial B \cap (r \cup s)| = 4$. Če se točke r in s prepletajo na meji ∂B pri neki okolici B (in zato pri vseh), pravimo, da se e in f oz. r in s *križata* v x , točko x pa označimo s pojmom *križišče*. Če se točke r in s na meji ∂B ne prepletajo, potem se e in f (r in s) v x *dotikata*, x pa poimenujemo *dotikaljšče*.

Risba D je *normalna*, če imata v D sliki poljubnih dveh povezav končen presek, D ne vsebuje dotikaljšč in se v vsakem križišču D sekata največ dve različni povezavi. Za normalno risbo D grafa G definiramo G_D kot *graf risbe* D ; njegova vozlišča so natanko vozlišča grafa G in križišča risbe D , dve vozlišči pa sta povezani, če med njima obstaja enostavna krivulja v risbi D , torej del risbe neke povezave G , ki ne vsebuje nobenega drugega vozlišča G_D .

Prekrižno število grafa G na Σ , $cr(G, \Sigma)$, je definirano kot minimalno število križišč na neki normalni risbi grafa G na Σ . S $cr(G)$ označimo prekrižno število grafa G na sferi oz. ravnini. Risba grafa na ravnini je homeomorfná risbi grafa na sferi, ki je opremljena z dodatno točko ∞ , katera ne leži na sliki kake povezave ali vozlišča. Licu ravninske risbe, ki vsebuje točko ∞ , rečemo *neskončno lice*. *Optimalna risba* grafa G na Σ je risba, ki ima natanko $cr(G, \Sigma)$ križišč. Zlahka preverimo, da je vsako optimalno risbo grafa G mogoče lokalno spremeniti v normalno risbo brez uvedbe novih križišč, zato bomo v nadaljevanju za vse risbe predpostavili, da so normalne.

Graf G je *k-prekrižno-kritičen* za Σ , če velja $cr(G, \Sigma) \geq k$ in $cr(H, \Sigma) < k$ za vsak pravi podgraf H grafa G . Graf je *prekrižno-kritičen* za Σ , če je *k-prekrižno-kritičen* za Σ za neki k . Kadar omembo ploskve izpustimo, predpostavimo kritičnost za ravnino (sfero).

Premočrtna risba enostavnega grafa je risba na ravnini \mathbb{R}^2 , na kateri je risba $\varepsilon(e, [0, 1])$ vsake povezave $e \in E(G)$ daljšica. *Premočrtno prekrižno število* $rcr(G)$ je najmanjšé število križišč na premočrtni risbi grafa G .

Prispevek disertacije k teoriji prekrižnega števila

Rezultati disertacije razširjajo teorijo prekrižnega števila v treh smereh: z novo konstrukcijo prekrižno-kritičnih grafov pokažemo na strukturo, ki jo lahko imajo tovrstni grafi, pokažemo več rezultatov o prekrižnih številih kartezičnih produktov grafov, poleg tega pa uvedemo minorsko monotono različico prekrižnega števila grafov.

Prekrižno-kritični grafi so minimalni s predpisanim prekrižnim številom, zato njihove lastnosti omogočajo vpogled v strukturno obnašanje te grafovske invariante. Uvedel jih je Širáň, ki je za vsak $k \geq 3$ konstruiral neskončno družino *k-prekrižno-kritičnih grafov* [127]. Kochol je za vsak $k \geq 2$ konstruiral

iral neskončno družino enostavnih k -prekrižno kritičnih grafov [72]. Richter in Thomassen sta začela opazovati stopnje vozlišč v enostavnih prekrižno-kritičnih grafih [105]. Najprej sta pokazala, da je prekrižno število takega grafa G omejeno z linearno funkcijo parametra k , $cr(G) \leq \frac{5}{2}k + 16$, iz česar sledi, da za vsak $k \geq 1$ in $r \geq 6$ obstaja le končno mnogo enostavnih k -prekrižno-kritičnih grafov z minimalno stopnjo r . Salazar je argument razširil na povprečno stopnjo: za vsak racionalen $r > 6$ obstaja le končno mnogo enostavnih k -prekrižno-kritičnih grafov s povprečno stopnjo r [111]. Konstruiral je neskončno družino enostavnih k -prekrižno-kritičnih grafov s povprečno stopnjo r za vsak racionalen $r \in [4, 6)$ ter za neskončno različnih k in zastavil naslednje vprašanje:

Vprašanje 1 ([111]). *Naj bo r racionalno število z intervala $(3, 4)$. Ali obstaja celo število k in neskončna družina (enostavnih) 3-povezanih grafov s povprečno stopnjo r , ki so vsi k -prekrižno-kritični?*

Na vprašanje 1 sta deloma pozitivno odgovorila Pinontoan in Richter, ki sta iskane družine konstruirala za $r \in (3\frac{1}{2}, 4)$ [96]. Za ta namen sta razvila teorijo tlakovcev, ki jo bomo uporabili tudi v pričujočem delu.

V nadaljevanju uvedemo novo grafovsko operacijo, *šiv*, s pomočjo katere lahko kombiniramo dva grafa ali dve risbi. Ob ustrezni povezanosti grafa pri vozliščih, ki so vpletena v šivanje, ta operacija ohranja prekrižno število grafov, ob zadostni simetriji v soseščini teh vozlišč pa ohranja tudi kritičnost grafov. Operacijo šivanja uporabimo skupaj z razširitvijo teorije tlakovcev Pinontoana in Richterja [96], ki omogoči posplošitev prekrižno-kritičnih grafov Kochola [72]. Tako izdelamo sedemparametrično družino prekrižno-kritičnih grafov, s pomočjo katere pokažemo osnovni rezultat tega dela: natančen izbor parametrov omogoča, da konstruiranim grafom predpišemo ne le poljubno racionalno povprečno stopnjo $r \in (3, 6)$, ampak tudi poljubno dovolj veliko prekrižno število, s čimer v polnosti odgovorimo na Salazarjevo vprašanje in v enem izreku zaobjamemo prej omenjene rezultate o obstoju neskončnih družin k -prekrižno-kritičnih grafov.

Poudarek na raziskovanju prekrižno-kritičnih grafov je bil na 3-(povezavno)-povezanih grafih. Ta pogoj onemogoči vozlišča stopnje dve, ki so trivialna za prekrižno število. Vendar je pogoj mnogo močnejši in šele pred kratkim sta ga upravičila Leños in Salazar, ko sta našla dekompozicijo 2-povezanih prekrižno-kritičnih grafov v 3-povezane komponente [75]. S pomočjo šivanja prekrižno-kritičnih grafov pokažemo, da podobna dekompozicija ne obstaja za k -povezane prekrižno kritične grafe, $k \geq 3$.

Zaradi obilice simetrije so kartezični produkti grafov pritegnili precej pozornosti pri določanju prekrižnih števil. Beineke in Ringeisen sta določila prekrižno število grafov $G \square C_n$ za vse grafe G reda štiri, razen za $K_{1,3}$ [12].

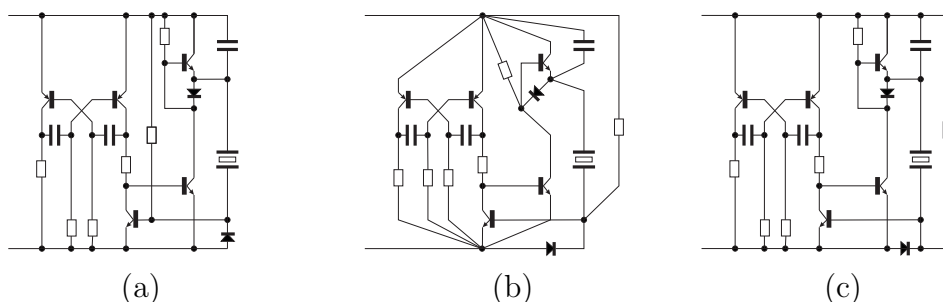

Slika 1: Minorsko prekrizno število in križišča v elektronskih vezjih.

To vrzel sta zapolnila Jendrol' in Ščerbová, ki sta poiskala prekrizno število $S_3 \square C_n$, $S_3 \square P_m$ in $S_4 \square P_2$ ter postavila naslednjo domnevo:

Domneva 2 ([57]). $\text{cr}(S_n \square P_m) = (m - 1) \lfloor \frac{n}{2} \rfloor \lfloor \frac{n-1}{2} \rfloor$ za $n \geq 3$, $m \geq 1$.

Klešč je domnevo pokazal za $n = 4$ in $m \geq 1$ v [66], kjer je določil tudi $\text{cr}(S_4 \square C_m)$ za $m \geq 3$. V [70] je določil prekrizno število $G \square P_m$ in $G \square S_n$ za vsak graf G reda štiri in v [67] prekrizno število $G \square P_m$ za vsak graf reda G pet. Za več grafov reda pet je znano tudi prekrizno število njihovega kartezičnega produkta s C_n ali S_n , poleg tega pa še več drugih kartezičnih produktov [66, 71, 67, 69, 68], največ jih je pokazal Klešč.

Kartezične produkte grafov z drevesi lahko iterativno sestavimo s pomočjo šivanja. Če pri tem zahtevamo spoštovanje pogoja povezanosti, ki zagotavlja ohranjanje prekriznega števila, nam kot motnja preostanejo le odvečna vozlišča, ki ustrezajo listom drevesa. V nekaterih primerih lahko z dodatno operacijo taka vozlišča dopolnimo do pravega kartezičnega produkta. Tako pokažemo več rezultatov o prekriznih številih kartezičnih produktov, med drugim o kartezičnem produktu zvezd $K_{1,n}$ in koles W_n z drevesi. V posebnem razrešimo domnevo Jendrol'a in Ščerbove za vsak $n, m \geq 1$.

Prekrizno število ima več uporab pri izdelavi integriranih vezij [13, 23, 76, 77, 122]. Pri tem je cilj poiskati ravninsko risbo grafa danega elektronskega vezja, ki ima najmanjše število križišč. Na ta način pa ne izkoristimo lastnosti elektronskega vezja, da imajo točke, povezane z navadnimi žicami, enak električni potencial. Zato lahko ustrezne povezave stisnemo in razširimo na drugačen način. S tem dobimo ekvivalentno elektronsko vezje, katerega graf pa ima lahko manjše prekrizno število. Ta pristop ilustriramo na sliki 1: (a) prikazuje originalno shemo visokofrekvenčnega oddajnika [129], (b) prikazuje ekvivalentno shemo, v kateri so točke z enakim potencialom stisnjene v eno vozlišče, (c) pa prikazuje shemo, ki je ekvivalentna prejšnjima dvema in ima eno križišče manj kot (a).

Minorsko prekrizno število, ki ga uvedemo v nadaljevanju, je naraven model za ta problem. Z njim iščemo najmanjše število križišč v taki risbi grafa, v kateri smo vozlišča nadomestili z drevesi in se povezave teh dreves lahko sekajo. Taka zamenjava v elektronskem vezju ustreza raztegnitvi točke z enakim potencialom v več žic. Tako dobljen *realizirajoči graf* vsebuje originalni graf G kot minor in ta različica prekriznega števila je minorsko monotona. S tem razrešimo problem, ki ga je odprl Seymour, ko je obžaloval, da prekrizno število ne sodeluje s teorijo grafovskih minorjev: odstranitev povezave prekriznega števila nikoli ne poveča, stiskanje povezave pa ga lahko spremeni v obe smeri [7].

V delu pokažemo več splošnih spodnjih mej za to grafovsko invarianto, raziščemo strukturo grafov z omejenim minorskim prekriznim številom in znanje o njej uporabimo za izboljšavo spodnjih mej. Ena od spodnjih mej je posplošitev rezultata Morene in Salazarja, ki sta podoben rezultat pokazala za grafe z maksimalno stopnjo štiri v [86]. Meje uporabimo na polnih grafih, polnih dvodelnih grafih, hiperkockah in na produktih dveh ciklov. Poleg tega pokažemo eksaktne vrednosti za male polne grafe K_n , $1 \leq n \leq 8$, ter za polne dvodelne grafe $K_{3,n}$ in $K_{4,n}$, $n \geq 1$.

Prekrizno-kritični grafi

Šiv grafov in risb

Za $i = 1, 2$ naj bo G_i graf in $v_i \in V(G_i)$ njegovo vozlišče stopnje d . Naj bo $N_i = N_{G_i}^*(v_i)$ multiokolica v_i in $\sigma : N_1 \rightarrow N_2$ bijekcija. Funkcijo σ imenujemo *igla* grafov G_1 in G_2 pri vozliščih v_1 in v_2 . *Šiv graf* G_1 in G_2 z iglo σ je graf $G_1 \odot_\sigma G_2$, ki ga dobimo iz disjunktne unije grafov $G_1 - v_1$ in $G_2 - v_2$, ko dodamo povezavo $u\sigma(u)$ za vsak $u \in N_1$. Z oznako $G_1 \underset{v_1 \odot v_2}{\odot} G_2$ opišemo množico paroma neizomorfni grafov, ki jih dobimo kot šiv $G_1 \odot_\sigma G_2$ za neko iglo $\sigma : N_1 \rightarrow N_2$.

Naj bo D_i risba grafa G_i . Ta določa rotacijo vozlišč iz N_i okrog vozlišča v_i . Vozlišča N_i usklajeno z rotacijo vozlišč označimo z bijekcijo $\pi_i : N_i \rightarrow \{1, \dots, d\}$. Funkcija $\sigma : N_1 \rightarrow N_2$, $\sigma = \pi_2^{-1}\pi_1$, je *igla* risb D_1 in D_2 pri vozliščih v_1 in v_2 . *Šiv risb* D_1 in D_2 z iglo σ je risba $D_1 \odot_\sigma D_2$, ki jo dobimo iz D_1 z vložitvijo zrcalne slike risbe D_2 , ki ima v_2 na neskončnem licu, disjunktno v neko lice D_1 , ki vsebuje v_1 , z odstranitvijo vozlišč v_1 in v_2 skupaj z njunima najhujšima diskastima okolicama ter s spojitvijo povezav okrog v_1 in v_2 v skladu z iglo σ , prim. sliko 2. Ker σ odraža zaporedje vozlišč okrog v_1 in v_2 , je povezave med D_1 in D_2 mogoče spojiti brez dodatnih križišč. Šiv risb $D_1 \odot_\sigma D_2$ je risba grafa $G_1 \odot_\sigma G_2$, torej velja naslednja lema:

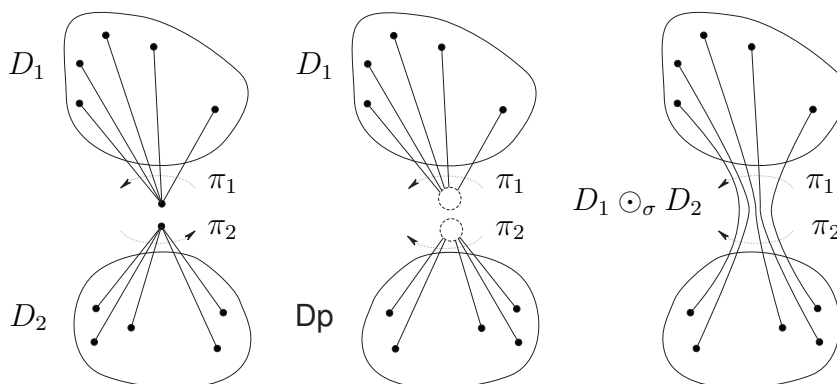
Slika 2: Šiv risb D_1 in D_2 .

Lema 3. Za $i = 1, 2$ naj bo D_i optimalna risba grafa G_i , $v_i \in V(G_i)$ vozlišče stopnje d in σ igla risb D_1 in D_2 pri v_1 in v_2 . Potem je $\text{cr}(G_1 \odot_\sigma G_2) \leq \text{cr}(G_1) + \text{cr}(G_2)$.

Kadar igla ne spoštuje rotacije vozlišč v optimalni risbi, je mogoče pokazati nekoliko šibkejšo zgornjo mejo:

Lema 4. Kadar je $G \in G_1 v_1 \odot_{v_2} G_2$ ter je za $i = 1, 2$ vozlišče $v_i \in V(G_i)$ stopnje d , velja $\text{cr}(G) \leq \text{cr}(G_1) + \text{cr}(G_2) + \binom{d-1}{2}$.

Naj bo $v \in V(G)$ vozlišče stopnje d v G . Butara B pri v je množica d povezavno disjunktne poti od v do nekega vozlišča $u \in V(G)$, $u \neq v$. Vozlišče v je začetek butare in u njen konec. Ostala vozlišča na poteh v B so notranja vozlišča butare. Za butaro B pri vozlišču $v \in V(G)$ naj $\check{E}(B) = E(B) \cap E(G - v)$ predstavlja množico povezav na poteh v B , ki niso sosednja z v . Imenujemo jih oddaljene povezave butare B . Dve butari B_1 in B_2 pri v sta usklajeni, če imata disjunktne množici oddaljenih povezav. Povezave butare B , ki niso oddaljene, so bližnje povezave.

Kadar šivamo grafe pri vozliščih, ki imajo butaro, prekrižno število novega grafa ne pade pod prekrižno število originalnega. To sledi iz naslednje leme, ki jo pokažemo s pomočjo razcepitve poti butare pri njenih notranjih vozliščih v risbi šiva. Nova risba vsebuje podrisbo subdivizije originalnega grafa. Ker nismo pridobili novih križišč, trditev velja.

Lema 5. Za $i = 1, 2$ naj bo G_i graf, $v_i \in V(G_i)$, $\deg(v_i) = d$, $N_i = N_{G_i}^*(v_i)$. Privzemimo, da obstaja butara B pri v_2 v G_2 in naj bo D risba $G = G_1 \odot_\sigma G_2$. Za poljubno iglo $\sigma : N_1 \rightarrow N_2$ je v D na povezavah iz $E(G_1 - v_1) \cup \check{E}(B)$ vsaj $\text{cr}(G_1)$ križišč.

Lemo 5 skupaj z ustrezno delitvijo križišč med štirimi (skoraj) subdivizijami grafov G_1 in G_2 v šivu uporabimo v dokazu naslednje spodnje meje, ki je ključna pri uporabi šivanja za dokazovanje prekrižnega števila grafov:

Lema 6. Za $i = 1, 2$ naj bo G_i graf in $v_i \in V(G_i)$ njegovo vozlišče stopnje d , $N_i = N_{G_i}^*(v_i)$ ter naj pri v_i obstajata dve usklajeni butari $B_{i,1}$ in $B_{i,2}$ v G_i . Potem velja $\text{cr}(G_1 \odot_\sigma G_2) \geq \text{cr}(G_1) + \text{cr}(G_2)$ za poljubno iglo $\sigma : N_1 \rightarrow N_2$.

Kadar je eden od grafov ravninski, namesto navedenih štirih zadošča zgolj ena butara pri vozlišču iz ravninskega grafa.

Šivanje večkrat uporabljamo iterativno. Za take primere pokažemo, da ob ustreznih pogojih ohranja (povezavno) povezanost grafov in število paroma usklajenih butar pri vozliščih šivanih grafov.

Poleg vrednosti prekrižnega števila lahko šivanje ohranja tudi kritičnost grafov. Pogoj, ki mu morata grafa zadoščati, je zadostna simetričnost sosedov šivanih vozlišč. Naj bo $S \subset V(G)$ množica vozlišč G in $\Gamma \subseteq \text{Aut}(G)$ podgrupa grupe avtomorfizmov grafa. Pravimo, da je S Γ -homogena v G , če za vsako permutacijo π elementov S obstaja avtomorfizem $\sigma \in \Gamma$, za katerega je $\sigma/S = \pi$. Za $S \subseteq V(G)$ naj $\Gamma(S)$ predstavlja stabilizator množice S v $\text{Aut}(G)$ po točkah. Vozlišče $v \in V(G)$ ima homogeno okolico v G , če je $N_G(v)$ $\Gamma(\{v\})$ -homogena v G . Zadosten pogoj za homogenost okolice v enostavnem grafu je, da imajo vsi sosedni isto množico sosedov. Tako so polni in polni dvodelni grafi primer grafov, v katerih ima vsako vozlišče homogeno okolico.

Vozlišče v grafa G je polaktivno, če pri njem obstajata dve usklajeni butari v G . Če ima v poleg tega tudi homogeno okolico v G in nima sosednjih večkratnih povezav, potem je v aktivno vozlišče. $\mathcal{S}(G)$ in $\mathcal{A}(G)$ zaporedoma označujeta množici polaktivnih in aktivnih vozlišč G .

Naslednji izrek omogoča izdelavo novih prekrižno-kritičnih grafov s šivanjem manjših prekrižno-kritičnih grafov. Dokažemo ga s šivanjem optimalnih risb teh manjših grafov, pri čemer simetrija v vozliščih zagotavlja, da je šiv mogoče brez uvedbe novih križišč izvesti tudi z optimalnimi risbami grafov, ki smo jim odstranili povezavo.

Izrek 7. Za $i = 1, 2$ naj bo G_i graf z vozliščem $v_i \in G_i$ stopnje d . Če je $v_1 \in \mathcal{S}(G_1)$ in $v_2 \in \mathcal{A}(G_2)$, potem za vsak graf $G \in G_1 \odot_{v_1, v_2} G_2$ velja:

$$(i) \text{ cr}(G) = \text{cr}(G_1) + \text{cr}(G_2).$$

Ob dodatni predpostavki $v_1 \in \mathcal{A}(G_1)$ velja:

$$(ii) \text{ Če je za } j = 1, 2 \text{ graf } G_j \text{ } k_j\text{-prekrižno-kritičen, potem je } G \text{ } k\text{-prekrižno-kritičen za } k = \max_j(\text{cr}(G_j) + k_{3-j}).$$

- (iii) Če za $j \in \{1, 2\}$ velja $v \in \mathcal{S}(G_j)$, $v \neq v_j$ in je $N_{G_j}(v)$ $\Gamma_{G_j}(\{v, v_j\})$ -homogena, potem $v \in \mathcal{A}(G)$.

Pri dokazu izreka 7 ne uporabimo dejstva, da lahko risbo pred šivanjem zrcalimo. Edina zanimiva razširitev izreka z uporabo zrcaljenja je pri vozliščih stopnje tri, ko lahko s pomočjo zrcaljenja in cikličnih rotacij dosežemo vse možne permutacije povezav v šivu. V tem primeru pri (i) in (ii) ni treba zahtevati pogoja homogenosti okolice, trditev (iii) pa ne velja. To posebnost vozlišč stopnje tri lahko izkoristimo tudi za izdelavo prekrižno-kritičnih grafov iz manjših, nekritičnih grafov. Kadar imajo slednji vozliščno pokritje iz polaktivnih vozlišč stopnje tri, lahko na vsako od vozlišč pokritja prišijemo prekrižno-kritičen graf, ki zagotovi kritičnost povezav, sosednjih z vozliščem šivanja.

Leaños in Salazar sta našla dekompozicijo 2-povezavno-povezanih prekrižno-kritičnih grafov na manjše 3-povezavno-povezane prekrižno-kritične grafe [75]. Zgornja konstrukcija pove, da za 3-povezavno-povezane prekrižno-kritične grafe podobna dekompozicija ne obstaja, saj obstajajo grafi z ustreznim vozliščnim pokritjem, ki niso prekrižno-kritični.

Tlakovci

Naj bo G graf in $\lambda = (\lambda_0, \dots, \lambda_l)$, $\rho = (\rho_0, \dots, \rho_r)$ dve disjunktne zaporedji vozlišč v G , v katerih vsako vozlišče G nastopa kvečjemu enkrat. Urejeni trojki $T = (G, \lambda, \rho)$ pravimo *tlakovci*. Risbi G na enotskem kvadratu $[0, 1] \times [0, 1]$, na katerega robovih ležijo natanko vozlišča *leve stene* λ na $\{0\} \times [0, 1]$ in *desne stene* ρ na $\{1\} \times [0, 1]$, rečemo *tlakovska risba* T , če je zaporedje padajočih y -koordinat vozlišč λ in ρ usklajeno z zaporedjema λ in ρ . *Tlakovsko prekrižno število* $\text{tr}(T)$ tlakovca T je najmanjše število križišč na kaki tlakovski risbi T .

Tlakovec $T = (G, \lambda, \rho)$ je *združljiv* s tlakovcem $T' = (G', \lambda', \rho')$, če velja $|\rho| = |\lambda'|$. Tlakovec T je *krožno združljiv*, če je združljiv sam s seboj. Zaporedje tlakovcev $\mathcal{T} = (T_0, \dots, T_m)$ je *združljivo*, če je T_i združljiv s T_{i+1} za $i = 0, \dots, m-1$. Zaporedje je *krožno združljivo*, če je združljivo in je T_m združljiv s T_0 . Za vsa zaporedja tlakovcev privzamemo, da so združljiva.

Spoj dveh združljivih tlakovcev T in T' je definiran kot $T \otimes T' = (G \otimes G', \lambda, \rho')$, kjer je $G \otimes G'$ graf, ki ga dobimo iz disjunktne unije grafov G in G' po identifikaciji ρ_i z λ'_i za $i = 0, \dots, |\rho| - 1$. Ker je operacija asociativna, lahko definiramo *spoj* združljivega zaporedja $\mathcal{T} = (T_0, \dots, T_m)$ kot tlakovec $\otimes \mathcal{T} = T_0 \otimes T_1 \otimes \dots \otimes T_m$. *Spoj* dveh tlakovcev lahko vsebuje dvojne povezave ali vozlišča stopnje dve. Dvojne povezave obdržimo, vozlišča stopnje dve pa odstranimo s stiskanjem ene od sosednjih povezav.

Za krožno združljiv tlakovec $T = (G, \lambda, \rho)$ definiramo njegov *krožni spoj* $\circ T$ kot graf, ki ga dobimo iz G po identifikaciji λ_i z ρ_i za $i = 0, \dots, |\rho| - 1$. Podobno definiramo krožni spoj krožno združljivega zaporedja tlakovcev kot $\circ \mathcal{T} = \circ(\otimes \mathcal{T})$. Ker lahko tlakovske risbe združljivih tlakovcev spajamo brez uvedbe novih križišč, velja naslednja lema:

Lema 8 ([96]). *Za krožno združljiv tlakovec T velja $\text{cr}(\circ T) \leq \text{tcr}(T)$. Za združljivo zaporedje tlakovcev $\mathcal{T} = (T_0, \dots, T_m)$ velja $\text{tcr}(\otimes \mathcal{T}) \leq \sum_{i=0}^m \text{tcr}(T_i)$.*

Za zaporedje ω naj $\bar{\omega}$ predstavlja obratno zaporedje. Naj bo $T = (G, \lambda, \rho)$ tlakovec. Njegov *desno-zviti* tlakovec T^\downarrow je $(G, \lambda, \bar{\rho})$, njegov *levo-zviti* tlakovec ${}^\uparrow T$ je $(G, \bar{\lambda}, \rho)$, njegov *zviti* tlakovec je ${}^\uparrow T^\downarrow = (G, \bar{\lambda}, \bar{\rho})$. *Obrnjeni* tlakovec tlakovca T je $T^{\leftrightarrow} = (G, \rho, \lambda)$.

Naj bo $\mathcal{T} = (T_0, \dots, T_m)$ zaporedje tlakovcev. *Obrat* zaporedja \mathcal{T} je $\mathcal{T}^{\leftrightarrow} = (T_m^{\leftrightarrow}, \dots, T_0^{\leftrightarrow})$. *Zvitje* zaporedja \mathcal{T} je $\mathcal{T}^\downarrow = (T_0, \dots, T_{m-1}, T_m^\downarrow)$. Za $i = 0, \dots, m$ je zaporedje $\mathcal{T}^i = (T_0, \dots, T_{i-1}, T_i^\downarrow, {}^\uparrow T_{i+1}, T_{i+2}, \dots, T_m)$ *i-skok* zaporedja \mathcal{T} . Zaporedje $\mathcal{T}/i = (T_{i+1}, \dots, T_m, T_0, \dots, T_{i-1})$ je *i-rez* zaporedja \mathcal{T} . Zaporedje $\mathcal{T}_i = (T_i, \dots, T_m, T_0, \dots, T_{i+1})$ je *i-prevoj* zaporedja \mathcal{T} . Pri zadnjih dveh operacijah predpostavljamo krožno združljivost zaporedja \mathcal{T} .

Dve zaporedji tlakovcev \mathcal{T} in \mathcal{T}' iste dolžine sta *ekvivalentni*, če lahko dobimo eno iz drugega z zaporedjem prevojev, skokov in obratov. Grafa, ki ju dobimo s krožnim spojem takih zaporedij, sta enaka.

Tlakovec $T = (G, \lambda, \rho)$ je *ravninski*, če velja $\text{tcr}(T) = 0$, in je *povezan*, če je G povezan. Je *popoln*, če velja (i) $|\lambda| = |\rho|$, (ii) grafa $G - \lambda$ in $G - \rho$ sta povezana, (iii) za vsak $v \in \lambda$ (in $v \in \rho$) v G obstaja pot do ρ (oz. λ), notranje disjunktna z λ (oz. ρ) in (iv) za vsak $0 \leq i < j \leq |\lambda|$ obstaja par disjunktnih poti P_{ij} in P_{ji} v G , tako da P_{ij} povezuje λ_i z ρ_i in P_{ji} povezuje λ_j z ρ_j .

Naj bo $T = (G, \lambda, \rho)$ tlakovec in H graf, ki vsebuje G kot podgraf. *Komplementarni tlakovec* za T v H je tlakovec $H - T = (H[(V(H) \setminus V(G)) \cup \lambda \cup \rho] - E(G), \rho, \lambda)$. Obravnavamo ga lahko kot komplement G v H , iz katerega smo odstranili vsa vozlišča T razen njegovih sten. Če velja $\circ(T \otimes (H - T)) = H$, t. j. vozlišča $\lambda \cup \rho$ ločijo G od $H - G$, pravimo, da je T *tlakovec v H* . Z uporabo tega koncepta naslednja lema pokaže bistveno lastnost popolnih tlakovcev. Izrek, ki sledi lemi, to lastnost uporabi za spodnjo mejo prekriznega števila grafov, ki jih dobimo s krožnim spojem zaporedij tlakovcev, njegova posledica pa za natančno določitev prekriznega števila. Splošnejšo obliko izreka potrebujemo v nadaljevanju za dokaz kritičnosti v konstrukciji prekrizno-kritičnih grafov iz zaporedij tlakovcev.

Lema 9. *Naj bo $T = (G, \lambda, \rho)$ popoln ravninski tlakovec v H , za katerega obstajata disjunktna podgrafa G_λ in G_ρ v H , vsebovana v isti komponenti*

$H - T$, za katera velja $G \cap G_\lambda = (\lambda, \emptyset)$, $G \cap G_\rho = (\rho, \emptyset)$. Če v neki risbi D grafa H na povezavah množice $E(G)$ in vsaj še ene od $E(G_\lambda)$ ali $E(G_\rho)$ ni križišč, potem sta D -inducirani risbi T in $H - T$ homeomorfni tlakovskima risbama.

Izrek 10. Naj bo $\mathcal{T} = (T_0, \dots, T_l, \dots, T_m)$ krožno združljivo zaporedje tlakovcev. Če velja $m \geq 4k - 2$ in za vsak $i = 0, \dots, m$, $i \neq l$, velja $\text{tcr}(\otimes(\mathcal{T}/i)) \geq k$ ter je T_i popoln ravninski tlakovec, potem velja $\text{cr}(\circ\mathcal{T}) \geq k$.

Posledica 11. Naj bo $\mathcal{T} = (T_0, \dots, T_l, \dots, T_m)$ krožno združljivo zaporedje tlakovcev in $k = \min_{i \neq l} \text{tcr}(\otimes(\mathcal{T}/i))$. Če je $m \geq 4k - 2$ in je T_i popoln ravninski tlakovec za vsak $i = 0, \dots, m$, $i \neq l$, potem je $\text{cr}(\circ\mathcal{T}) = k$.

Tlakovec T je k -izrojen, če je popoln, ravninski in za vsako povezavo $e \in E(T)$ velja $\text{tcr}(T^\dagger - e) < k$. Zaporedje tlakovcev $\mathcal{T} = (T_0, \dots, T_m)$ je k -kritično, če je tlakovec T_i k -izrojen za vsak $i = 0, \dots, m$ in je $\min_{i \neq m} \text{tcr}(\otimes(\mathcal{T}^\dagger/i)) \geq k$. Naslednjo splošno konstrukcijo k -prekrižno-kritičnih grafov pokažemo s pomočjo k -kritičnih zaporedij tlakovcev in izreka 10.

Posledica 12. Naj bo $\mathcal{T} = (T_0, \dots, T_m)$ k -kritično zaporedje tlakovcev. Potem je $T = \otimes\mathcal{T}$ k -izrojen tlakovec. Če je $m \geq 4k - 2$ in je \mathcal{T} krožno združljivo, potem je $\circ(T^\dagger)$ k -prekrižno-kritičen graf.

Z izrekom 10 in posledicama 11 ter 12 smo ugotavljanje prekrižnega števila grafa in njegove kritičnosti prevedli na ugotavljanje tlakovskega prekrižnega števila. V nadaljevanju razvijemo ovire, s pomočjo katerih si pri slednjem lahko pomagamo. V splošnem je v danem tlakovcu lahko prisotnih več ovir. Če so te *konsistentne*, potem so križišča, ki jih povzročijo v tlakovski risbi, različna. Primer konsistentnih ovir so povezavno disjunktne ovire, pojem konsistentnosti pa lahko opredelimo širše s pomočjo teorije množic.

Zviti par $\{P, Q\}$ v tlakovcu $T = (G, \lambda, \rho)$ je ovira, sestavljena iz dveh *prekrižanih prečnih poti*, t. j. disjunktne poti od λ do ρ , katerih začetka z indeksoma $i(P), i(Q)$, si v λ sledita v obratnem vrstnem redu kot njuna konca z indeksoma $j(P), j(Q)$ v ρ . V vsaki tlakovski risbi T mora biti vsaj eno križišče povezave prve poti iz zvitega para s povezavo druge poti. Konsistentni družini zvitih parov rečemo *zvita družina*. Moč vsake zvite družine v tlakovcu je spodnja meja za njegovo tlakovsko prekrižno število.

Par prečnih poti, ki ni zvit, je *poravnan*, *poravnana družina* pa je konsistentna družina poravnanih parov. Naj bo tlakovec T združljiv s tlakovcem T' in naj bo $\{P, Q\}$ zvit par v T . Poravnan par $\{P', Q'\}$ v T' *razširja* $\{P, Q\}$ na desno, če velja $j(P) = i(P')$, $j(Q) = i(Q')$. V tem primeru je $\{PP', QQ'\}$ zvit par v spoju $T \otimes T'$. *Desno-razširjajoča družina* \mathcal{F}' zvite

razen parov P_1, P_2 in P_{n-1}, P_n , za katera zahtevamo zgolj povezavno disjunktnost. Za $u \in V(P_1) \cap V(P_2)$ in $v \in V(P_{n-1}) \cap V(P_n)$ pravimo, da je u levo od v (prim. sliko 3), če obstajata notranje disjunktni poti Q_u in Q_v od u do v z naslednjimi lastnostmi:

- (s.i) na poti Q_u obstajajo vozlišča $u_1, u'_1, u_2, u'_2, \dots, u_n, u'_n$ v tem vrstnem redu,
- (s.ii) na poti Q_v obstajajo vozlišča $v_1, v'_1, v_2, v'_2, \dots, v_n, v'_n$ v tem vrstnem redu,
- (s.iii) $u = u_1 = u'_1 = u_2 = v_1$ in $v = u'_n = v'_{n-1} = v_n = v'_n$,
- (s.iv) $v'_1, v_2, v'_2, u'_2 \notin P_1 \cap P_2$ in $v_{n-1}, u_{n-1}, u'_{n-1}, u_n \notin P_{n-1} \cap P_n$,
- (s.v) za $i = 1, \dots, n$ velja $R_i := u_i P_i u'_i \subseteq P_i \cap Q_u$, z enakostjo pri $i \neq n-1$,
- (s.vi) za $i = 1, \dots, n$ velja $S_i := v_i P_i v'_i \subseteq P_i \cap Q_v$ z enakostjo pri $i \neq 2$,
- (s.vii) $R_{n-1} = P_{n-1} \cap Q_u - R_n$ in $S_2 = P_2 \cap Q_v - S_1$,
- (s.viii) če sta $'u, u' \in P_1 \cap P_2$ dve vozlišči, za kateri velja $v'_1 \in 'u P_1 u'$, potem $v_2 \in 'u P_2 u'$,
- (s.ix) če sta $'v, v' \in P_{n-1} \cap P_n$ dve vozlišči, za kateri velja $u_n \in 'v P_n v'$, potem $u'_{n-1} \in 'v P_{n-1} v'$, in
- (s.x) $\lambda(P_i)u_i u'_i v_i v'_i \rho(P_i)$ ležijo v tem vrstnem redu na P_i za vsak $i = 1, \dots, n$.

Podobno definiramo, da je u desno od v . Družina poti \mathcal{P} tvori *zviti stopničasti trak* širine n v tlakovcu T , če je za vsak par $u \in V(P_1) \cap V(P_2)$ in $v \in V(P_{n-1}) \cap V(P_n)$ vozlišče u levo ali desno od v . Na sliki 3 je vozlišče u levo od vozlišča v ; izpostavljene so vse posebnosti grafa, ki to dokazujejo. Poti $u'_i Q_u u_{i+1}$ in $v'_i Q_v v_{i+1}$ so za $i = 2, \dots, n-1$ in $j = 1, \dots, n$ notranje disjunktne od P_j po (s.v) in (s.vi) in njihova dolžina je vsaj ena. Na sliki so predstavljene z navpičnimi povezavami. Dolžina poti R_i in S_i , $i = 1, \dots, n$, pa je lahko nič; primere s pozitivno dolžino smo izpostavili s krepkimi povezavami. Nепrekinjene povezave na sliki 3 so del zvitega stopničastega traku, prekinjene niso. Vozlišči u in s sta levo od v in vozlišči s' in s'' sta desno od v .

Množica n poti v zvitem traku določa $\binom{n}{2} - 2$ konsistentnih zvitih parov, kar je po posledici 13 spodnja meja za tlakovsko prekrizno število tlakovca s takim trakom. S pomočjo lastnosti (s.i)–(s.x) pokažemo, da mora vedno obstajati vsaj še eno križišče.

Izrek 14. *Naj bo T tlakovec, v katerem $\mathcal{P} = \{P_1, P_2, \dots, P_n\}$ tvori zviti stopničasti trak širine n . Potem je $\text{tcr}(T) \geq \binom{n}{2} - 1$.*

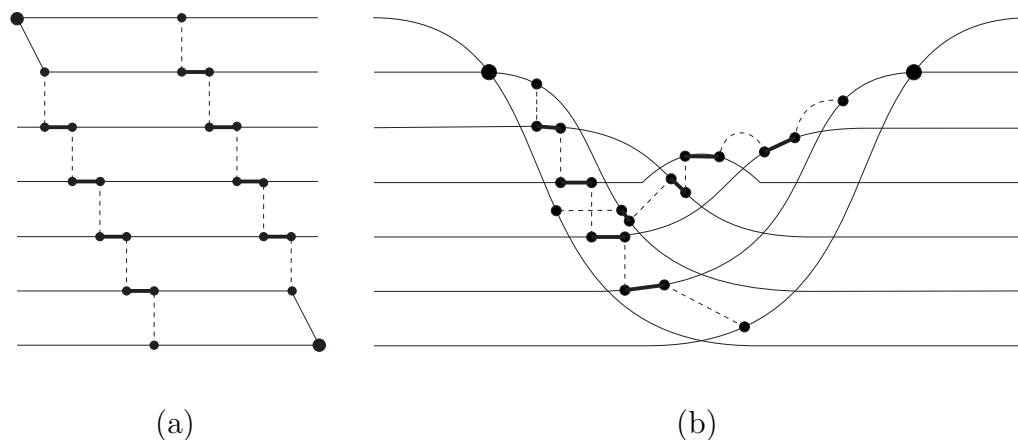

Slika 4: (a) Tlakovec S_7 . (b) Tlakovska risba S_7 z 20 križišči.

V dokazu usmerimo poti P_i od leve proti desni steni. Najprej pokažemo, da lahko predpostavimo, da sliki vsakih dveh poti delita največ eno točko. To da skupaj z usmeritvijo povezav risbi dovolj strukture, da lahko poiščemo novo križišče na povezavah poti Q_u in Q_v , pri čemer sta $u \in V(P_1) \cap V(P_2)$ in $v \in V(P_{n-1}) \cap V(P_n)$ vozlišči, kjer se v tlakovski risbi sekata sliki teh dveh parov poti (če katera od teh točk ne bi bila vozlišče, bi bilo križišč že dovolj).

Poleg zvitih parov in zvitih stopničastih trakov definiramo še več drugih ovir: podvojena vozlišča, kolesne ovire, mostove, prečne pare, prepletene pare, ter eno- ali dvostranske trinožnike. Vse zagotavljajo vsaj eno ali dve križišči v tlakovski risbi. V delu uporabimo le kolesno oviro, s katero si pomagamo pri dokazovanju prekrižnega števila nekaterih kartezičnih produktov.

Konstrukcije

Bralec bo brez težav eksaktno opisal tlakovec S_n , $n \geq 3$, katerega primer je za $n = 7$ prikazan na sliki 4 (a). Stopničasti tlakovec širine $n \geq 3$, ki je popoln ravninski tlakovec, dobimo iz S_n s stiskanjem nekaj (morda nič) krepkih povezav S_n . Stopničasto zaporedje širine n je zaporedje tlakovcev lihe dolžine, v katerem stopničasti tlakovci širine n alternirajo z obrnjenimi stopničastimi tlakovci širine n . Vsako stopničasto zaporedje je krožno združljivo in tlakovec, ki ga dobimo s spojem zvitja takega zaporedja, vsebuje zvit stopničast trak. Z uporabo leme 8, posledic 11 in 12 ter izreka 14 dokažemo naslednjo trditev:

Trditev 15. Naj bo \mathcal{T} stopničasto zaporedje širine n in lihe dolžine $m \geq 4\binom{n}{2} - 5$. Graf $G = \circ(\mathcal{T}^\uparrow)$ je prekrižno-kritičen s prekrižnim številom $cr(G) = \binom{n}{2} - 1$.

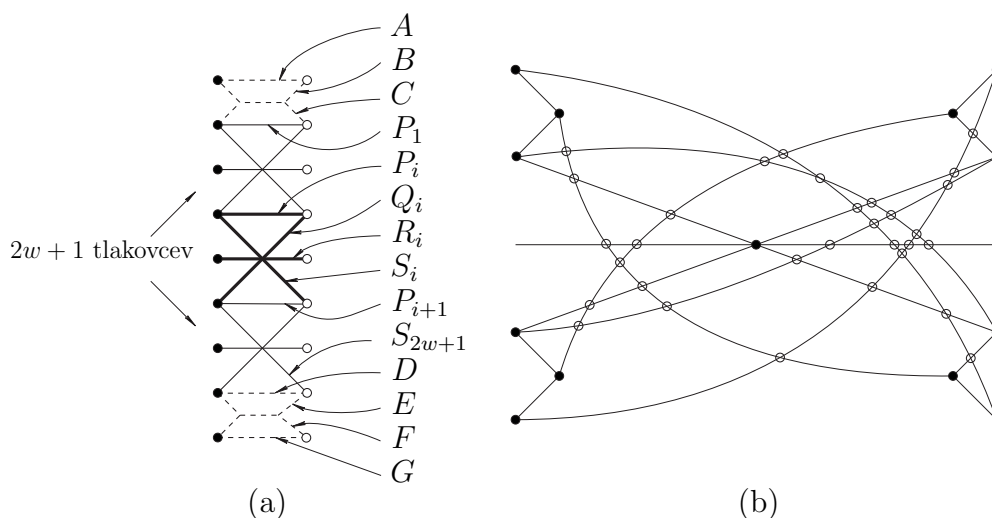

Slika 5: (a) Tlakovec H_1 , gradnik grafa $H(1, s)$. (b) Optimalna tlakovska risba H_0 .

S pomočjo krožnih spojev stopničastih zaporedij lahko pozitivno odgovorimo na Salazarjevo vprašanje za vsak $r \in (3, 4)$, kjer je $r = 3 + \frac{a}{b}$ in sta a in b različne parnosti. Če sta enake parnosti, potem bi morala biti dolžina stopničastega zaporedja tlakovcev soda, krožni spoj takega zaporedja pa ne bi bil prekrizno-kritičen graf.

Naj bo H_w tlakovec, ki je za $w = 1$ predstavljen na sliki 5 (a). Zgrajen je iz podtlakovcev, predstavljenih s prekinjenimi črtami, ki ju spojimo z zaporedjem $2w + 1$ podtlakovcev, od katerih je eden predstavljen s krepkimi črtami. Vozlišča leve (desne) stene tlakovca H_w so obarvana črno (bela). H_w je popoln ravninski tlakovec. Oznaka $\mathcal{H}(w, s) = (H_w, \dots, H_w)$ naj predstavlja zaporedje teh tlakovcev dolžine s , $H(w, s) = \circ(\mathcal{H}(w, s))^\dagger$ pa naj bo krožni spoj zvitja takega zaporedja. V tlakovcu H_w lahko najdemo družino zvitih parov, ki ga nasiti in zapolni zaporedje $\mathcal{H}(w, s)$, zato po posledicah 12 in 13 velja naslednja trditev:

Trditev 16. Za $k = 32w^2 + 56w + 31$ in $s \geq 4k - 1$ je graf $H(w, s)$ prekrizno-kritičen graf s prekriznim številom k .

Za $d, d' \geq 3$ naj $K_{d,d'}$ predstavlja polni dvodelni graf s pravilno obarvanimi vozlišči: vozlišča stopnje d naj bodo črna in vozlišča stopnje d' naj bodo bela. Za $p \geq 1$ naj družina $\mathcal{R}(d, d', p)$ predstavlja grafe z obarvanimi vozlišči, ki jih dobimo iterativno z $\mathcal{R}(d, d', 1) = \{K_{d,d'}\}$ in $\mathcal{R}(d, d', p) = \bigcup_{G \in \mathcal{R}(d, d', p-1)} G_{v_1 \odot v_2} K_{d,d'}$. Pri tem sta v_1 in v_2 črni vozlišči v G (oz. $K_{d,d'}$). Če velja $d = d' = 3$, je v_i

lahko katerokoli vozlišče. Pri šivanju grafov ohranimo barve vozlišč, zato grafi v $\mathcal{R}(d, d', p)$ niso pravilno obarvani za $p \geq 2$. Za take grafe z induktivno uporabo izreka 7 (iii) pokažemo, da so vsa črna vozlišča aktivna. Tako po izreku 7 (ii) oz. po ustrezni trditvi za vozlišča stopnje tri velja naslednja trditev:

Trditev 17. *Za $d, d' \geq 3$ je vsak graf $G \in \mathcal{R}(d, d', p)$ enostaven 3-povezan prekrizno-kritičen graf s prekriznim številom $cr(G) = p cr(K_{d,d'})$.*

Jaeger je pokazal, da ima vsak 3-povezan kubičen graf s prekriznim številom ena kromatični indeks tri. Grafi iz družine $\mathcal{R}(3, 3, p)$ v sivu s Petersenovim grafom zagotavljajo, da ni mogoča posplošitev Jaegrovega rezultata na grafe s prekriznim številom enakim k za noben $k \geq 2$.

Družine $\mathcal{S}(n, m, c)$, $H(w, s)$, $\mathcal{R}(3, 3, p)$ in $\mathcal{R}(3, 5, q)$ uporabimo v razrešitvi Salazarjevega vprašanja in hkratnem kombiniranju odgovora z rezultati Širāna in Kochola.

Izrek 18. *Naj bo $r \in (3, 6)$ racionalno število. Obstaja zvezna konveksna funkcija $f : (3, 6) \rightarrow \mathbb{R}^+$, tako da za vsako celo število $k \geq f(r)$ obstaja neskončna družina enostavnih 3-povezanih prekrizno-kritičnih grafov s povprečno stopnjo r in prekriznim številom k .*

Izrek dokažemo konstruktivno za

$$f(r) = 240 + \frac{512}{(6-r)^2} + \frac{224}{6-r} + \frac{25}{16(r-3)^2} + \frac{40}{r-3}.$$

Pri tem sestavimo sedemparametrično družino $\Gamma(n, m, c, w, s, p, q)$, ki vsebuje šive grafov iz $\mathcal{S}(n, m, c)$, $H(w, s)$, $\mathcal{R}(3, 3, p)$ in $\mathcal{R}(3, 5, q)$. Grafi $H(w, s)$ omogočajo povprečno stopnjo blizu šest in grafi iz \mathcal{S} omogočajo povprečno stopnjo blizu tri. Disjunktna unija dveh takih grafov sestavljenih iz sorazmernega števila tlakovcev bi imela predpisano povprečno stopnjo in prekrizno število. Ko taka grafa sešijemo, šiv pokvari vzorec, ki zagotavlja predpisano povprečno stopnjo. To nepravilnost odpravimo z grafi iz \mathcal{R} , s katerimi zagotovimo tudi predpisano prekrizno število.

Ker imajo vsa vozlišča stopnje tri v navedenih grafih dve usklajeni butari, so grafi iz $\Gamma(n, m, c, w, s, p, q)$ prekrizno-kritični po izreku 7 in trditvah 15, 16 in 17, kadar je zadoščeno naslednjim pogojem: $n \geq 3$, $m = 2m' + 1$, $m' \geq 2\binom{n}{2}$, $c \geq 0$, $c \leq 2m(n-3)$, $w \geq 0$, $s \geq 4(32w^2 + 56w + 31)$, $p \geq 1$ in $q \geq 1$.

Prekrizno število omenjenih grafov je enako

$$k = \binom{n}{2} + 32w^2 + 56w + p + 4q + 30, \quad (1)$$

povprečna stopnja pa

$$\bar{d} = 6 - \frac{4(m'(6n-11) + 3n + 3p + 3q + 4s - c - 7)}{2m'(4n-7) + 4n + 4sw + 9s + 4p + 6q - c - 9}. \quad (2)$$

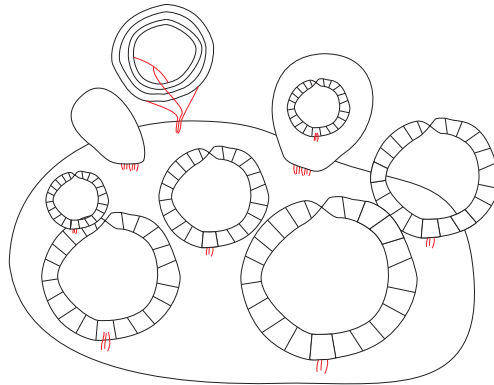

Slika 6: Struktura znanih velikih k -prekrižno-kritičnih grafov.

Enakost (1) določi p z vrednostmi predpisanega prekrižnega števila k in ostalih parametrov. Da bosta ciklični strukturi rastli sorazmerno, določimo s in m kot linearni funkciji novega parametra t , ki določa velikost grafa. Ko te vrednosti vstavimo v (2), uporabimo c za izničenje členov imenovalca, ki so neodvisni od t . S parametrom q izničimo take člene v števcu. Vrednost t se pokrajša, kar zagotovi, da bodo grafi za vsak t imeli predpisano povprečno stopnjo, ki jo določimo z vrednostima koeficientov linearnih funkcij. Na koncu z vrednostmi parametrov n in w ter konstantnih členov linearnih funkcij poskrbimo, da je zadoščeno prej naštetim pogojem. Dobljena družina $\Gamma(a, b, k) = \bigcup_{t=k}^{\infty} \Gamma(n, m_t, c, w, s_t, p, q)$ je neskončna družina grafov s povprečno stopnjo $r = 3 + \frac{a}{b}$ in prekrižnim številom k . Funkcija f je konveksna na intervalu $(3, 6)$, saj je vsota funkcij, ki so konveksne na tem intervalu. Ta lastnost pove, da je $N_I = \max\{f(r_1), f(r_2)\}$ univerzalna spodnja meja za vrednost k za vsa racionalna števila r s poljubnega zaprtega intervala $I = [r_1, r_2] \subseteq (3, 6)$.

Struktura prekrižno-kritičnih grafov

Oporowski [87] je pokazal, da je mogoče velike 2-prekrižno-kritične grafe dobiti kot krožne spoje dolgih zaporedij nekaj različnih vrst tlakovcev. Konstrukcija prekrižno-kritičnih grafov s šivanjem pokaže, da za $k \geq 4$ taka klasifikacija ne obstaja, saj bi lahko s šivanjem pridobili poljubno mnogo različnih tlakovcev z enakim tlakovskim prekrižnim številom. Ta konstrukcija tudi pokaže, da je za velike k mogoče dobiti prekrižno-kritične grafe s šivanjem manjših takih grafov na nekritične grafe z ustreznim vozliščnim pokritjem. Nova spoznanja o strukturi prekrižno-kritičnih grafov prikazuje slika 6.

Glede stopenj vozlišč v k -prekrižno-kritičnih grafih ostajata odprti naslednji vprašanji:

Vprašanje 19 ([105]). *Ali obstaja celo število $k > 0$ in neskončna družina enostavnih 5-regularnih 3-povezanih k -prekrižno-kritičnih grafov?*

Vprašanje 20. *Ali obstaja $k > 0$ in neskončna družina enostavnih 3-povezanih k -prekrižno-kritičnih grafov s povprečno stopnjo šest?*

Argumente, s katerimi Richter in Thomassen v [105] pokažeta, da za $k > 0$ obstaja le končno mnogo k -prekrižno-kritičnih grafov z minimalno stopnjo šest, je mogoče uporabiti za grafe z omejenim številom vozlišč stopnje različne od šest. Tako lahko predpostavimo, da bi družina, ki bi pozitivno odgovorila na vprašanje 20, vsebovala grafe s poljubno mnogo vozlišči stopnje, večje od šest. Vendar pa se v znanih neskončnih družinah k -prekrižno-kritičnih grafov le vozlišča stopenj tri, štiri in šest pojavljajo poljubnomnogokrat. Tako predlagamo naslednje vprašanje, odgovor na katerega bi bil korak v smeri razrešitve vprašanj 19 in 20.

Vprašanje 21. *Ali obstaja tak $k > 0$, da za vsako celo število n obstaja enostaven 3-povezan k -prekrižno-kritičen graf G_n z več kot n vozlišči stopenj različnih od tri, štiri in šest?*

Šiv grafa $K_{3,d}$ in grafov iz znanih neskončnih družin k -prekrižno-kritičnih grafov pokaže, da obstajajo neskončne družine prekrižno-kritičnih grafov s poljubno mnogo vozlišči stopnje d . Vendar prekrižno število grafov teh družin narašča s številom takih vozlišč.

Kartezični produkti

Naj $G^{(i)}$ predstavlja *suspencijo* reda i grafa G , t. j. popolni spoj grafa G in praznega grafa na i vozliščih $\{v_1, \dots, v_i\}$, ki jih imenujemo *temena* suspencije $G^{(i)}$. Za multimnožico $L \subseteq V(H)$ naj $G \square_L H$ predstavlja *pokriti kartezični produkt* grafov G in H , t. j. graf, ki ga dobimo z dodajanjem novega vozlišča v' k grafu $G \square H$ za vsako vozlišče $v \in L$, pri čemer v' povežemo z vsemi vozlišči v $G \square \{v\}$. Vozlišče v' imenujemo *pokrov* vozlišča v . Ko L vsebuje natanko vsa vozlišča stopnje ena v H , uporabimo oznako $G \widehat{\square} H$ namesto $G \square_L H$. Za $v \in V(H)$ definiramo $\ell(v) := \deg_H(v) + \chi_L(v)$, kjer $\chi_L(v)$ predstavlja mnogokratnost vozlišča v v multimnožici L . Povezava $uv \in E(H)$ je *neuravnovešena*, če je $\ell(u) \neq \ell(v)$, $\beta(H)$ pa predstavlja število neuravnovešenih povezav v H . V tem kontekstu z induktivno uporabo šivanja optimalnih risb suspencij pokažemo naslednji izrek:

Izrek 22. Naj bo T drevo reda $m \geq 2$, $L \subseteq V(T)$ multimnožica z $\ell(v) \geq 2$ za vsak $v \in V(T)$ in G graf reda n z dominirajočim vozliščem v . Definiramo

$$B = \sum_{v \in V(T)} \text{cr}(G^{\ell(v)}).$$

Potem velja $B \leq \text{cr}(G \square_L T) \leq B + \beta(T) \binom{n-1}{2}$. Kadar grupa avtomorfizmov G deluje kot polna simetrična grupa na sosedih v v G , velja enakost $\text{cr}(G \square_L T) = B$.

Zgornji izrek velja za vsak graf G , če zahtevamo $\ell(v) \geq 3$. Ta pogoj zagotavlja zadostno število butar v suspenziji grafa G .

Preprosta posledica izreka je, da velja $\text{cr}(G \square P_m) = (m+1) \text{cr}(G^{(2)})$ za graf G z dominirajočim vozliščem $m \geq 0$. Dobimo tudi meje za prekržno število navadnega kartezičnega produkta: za graf G reda n z dominirajočim vozliščem in za $m \geq 2$ velja

$$(m-1) \text{cr}(G^{(2)}) \leq \text{cr}(G \square P_m) \leq (m-1) \text{cr}(G^{(2)}) + 2 \left(\text{cr}(G^{(1)}) + \binom{n-1}{2} \right).$$

Ta trditev omogoča asimptotično določanje prekržnega števila kartezičnega produkta grafov s potmi.

Za produkte ciklov z drevesi lahko pokažemo naslednjo trditev, pri kateri bistveno uporabimo Kleitmanove in Woodalove rezultate o prekržnem številu polnih dvodelnih grafov [65, 134]

Posledica 23. Naj za celi števili n in d velja eden od pogojev (i) $3 \leq n$ in $1 \leq d \leq 6$, (ii) $3 \leq n \leq 6$ in $1 \leq d$, (iii) $3 \leq n \leq 8$ in $1 \leq d \leq 10$ oz. (iv) $3 \leq n \leq 10$ in $1 \leq d \leq 8$. Potem za vsako drevo T z maksimalno stopnjo d in za $d_v = \deg_T(v)$, $v \in V(T)$, velja:

$$\text{cr}(C_n \widehat{\square} T) = \sum_{v \in V(T)} \left\lfloor \frac{n}{2} \right\rfloor \left\lfloor \frac{n-1}{2} \right\rfloor \left\lfloor \frac{d_v}{2} \right\rfloor \left\lfloor \frac{d_v-1}{2} \right\rfloor.$$

Suspenzija zvezde $S_n^{(d)}$ je izomorfná polnemu tripartitnemu grafu $K_{1,d,n}$, ki ga dobimo s stiskanjem ene povezave v $K_{d+1,n+1}$. Graf $S_n \square S_d$ je subdivizija grafa $S_n^{(d)}$. Tako lahko prekržno število kartezičnega produkta drevesa in zvezde s pomočjo izreka 22 zapišemo kot vsoto prekržnih števil kartezičnih produktov dveh zvezd:

$$\text{cr}(S_n \square T) = \sum_{v \in V(T), d_v \geq 2} \text{cr}(K_{1,d_v,n}).$$

S pomočjo Asanovega rezultata o prekržnem številu $K_{1,3,n}$ lahko pokažemo naslednje:

Posledica 24. Za celo število $n \geq 1$ in podkubično drevo T z n_2 vozlišči stopnje dve in n_3 vozlišči stopnje tri velja

$$\text{cr}(S_n \square T) = \left\lfloor \frac{n}{2} \right\rfloor \left((n_2 + 2n_3) \left\lfloor \frac{n-1}{2} \right\rfloor + n_3 \right).$$

Za poljubno drevo T velja

$$\text{cr}(S_3 \square T) = \sum_{v \in V(T), d_v \geq 2} \left\lfloor \frac{d_v}{2} \right\rfloor \left(2 \left\lfloor \frac{d_v-1}{2} \right\rfloor + 1 \right).$$

Poseben primer posledice 24 sta Jendrol' in Ščerbová domnevala v [57].

Posledica 25. $\text{cr}(S_n \square P_m) = (m-1) \left\lfloor \frac{n}{2} \right\rfloor \left\lfloor \frac{n-1}{2} \right\rfloor$ za $m, n \geq 1$.

Tudi pri kartezičnemu produktu koles si lahko pomagamo s subdivizijami, vendar moramo dodati za en cikel povezav, s čimer povečamo prekrizno število grafa. Najprej formaliziramo to operacijo: naj bo π permutacija podmnožice povezav $F \subseteq E(G)$. π -subdivizija G^π grafa G je graf, ki ga dobimo iz G s subdividiranjem povezav $e \in F$ z vozliščem v_e in dodajanjem novih povezav $\{v_e v_{\pi(e)} \mid e \in F\}$. Če F predstavlja množico povezav, sosednjih z nekim vozliščem, in π ciklično rotacijo povezav okrog tega vozlišča v neki optimalni risbi G , potem π -subdivizija ne spremeni prekriznega števila grafa. Če pa nekaj povezav izpustimo in nam ostanejo vsaj tri, potem se v primeru, da pri tem vozlišču obstaja butara, prekrizno število poveča vsaj za ena. S pomočjo te ugotovitve ter leme, da za $n \geq 3$ velja $\text{cr}(W_n^{(2)}) = \left\lfloor \frac{n}{2} \right\rfloor \left\lfloor \frac{n-1}{2} \right\rfloor + 1$, ugotovimo natančno prekrizno število kartezičnega produkta kolesa s potjo:

Posledica 26. $\text{cr}(W_n \square P_m) = (m-1) \left(\left\lfloor \frac{n}{2} \right\rfloor \left\lfloor \frac{n-1}{2} \right\rfloor + 1 \right) + 2$ za $m \geq 2, n \geq 3$.

Z analizo primerov ugotovimo tudi $\text{cr}(W_3^{(3)}) = 5$, iz česar sledi zametek analoga posledice 24 za kolesa:

Posledica 27. $\text{cr}(W_3 \square T) = n_1 + 2n_2 + 5n_3$ za podkubično drevo T z n_i vozlišči stopnje i , $i = 1, 2, 3$.

Minorsko prekrizno število

V tem razdelku s pomočjo tehnik za izdelavo minorsko monotonih invariant, ki jih je študiral Fijavž [38], uvedemo minorsko monotono različico prekriznega števila. Rezultati razdelka so osnovani na raziskavah Fijavža, Moharja in avtorja te disertacije, objavljenih v [20]. Pred tem delom je bilo znanih le malo

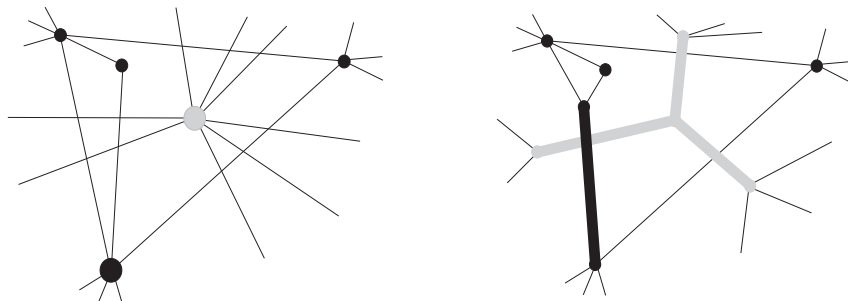

Slika 7: mcr kot razširitev cr.

rezultatov, ki so povezovali presečno število z grafovskimi minorji. Moreno in Salazar sta objavila spodnjo mejo za presečno število grafa, ki temelji na presečnem številu njegovega minorja majhne maksimalne stopnje [86]. Njun rezultat posplošimo v nadaljevanju. Robertson in Seymour [109] sta določila prepovedane minorje za lastnost *biti minor grafa s presečnim številom največ ena*. Strukturo risb grafov, ki izhajajo iz te lastnosti, raziščemo tudi za večja presečna števila in jo uporabimo za izboljšavo spodnje meje, ki izhaja iz Eulerjeve formule.

Minorsko presečno število iskanega grafa G v ploskvi Σ definiramo kot najmanjše presečno število grafa, ki vsebuje G kot minor,

$$\text{mcr}(G, \Sigma) := \min \{ \text{cr}(H, \Sigma) \mid G \leq_m H \}$$

in z $\text{mcr}(G)$ označimo $\text{mcr}(G, \mathbb{S}_0)$. Podobno definiramo *majorsko presečno število* grafa G kot največje presečno število v kakem minorju G ,

$$\text{Mcr}(G, \Sigma) := \max \{ \text{cr}(H, \Sigma) \mid H \leq_m G \} .$$

Iz definicije izhajajo neenakost $\text{mcr}(G, \Sigma) \leq \text{cr}(G, \Sigma) \leq \text{Mcr}(G, \Sigma)$ za vsak graf G in vsako ploskev Σ , prav tako očitno za vsak minor G grafa H v vsaki ploskvi velja $\text{mcr}(G, \Sigma) \leq \text{mcr}(H, \Sigma)$ in $\text{Mcr}(G, \Sigma) \leq \text{Mcr}(H, \Sigma)$. Ker sta $\text{mcr}(\cdot, \Sigma)$ in $\text{Mcr}(\cdot, \Sigma)$ minorsko monotoni, sta družini

$$\omega(k, \Sigma) = \{ G \mid \text{mcr}(G, \Sigma) \leq k \} \text{ in } \Omega(k, \Sigma) = \{ G \mid \text{Mcr}(G, \Sigma) \leq k \}$$

zaprti za minorje.

Za vsak graf G obstaja graf \bar{G} , ki vsebuje G kot minor in za katerega velja $\text{mcr}(G, \Sigma) = \text{cr}(\bar{G}, \Sigma)$. Vsakemu takemu grafu \bar{G} rečemo *realizirajoči graf* grafa G , njegova optimalna risba v ploskvi Σ pa je *realizirajoča risba* grafa G (glede na Σ). Privzeli bomo, da imata G in \bar{G} enako število povezanih komponent.

Ker je G minor realizirajočega grafa \bar{G} , ga lahko dobimo iz podgrafa \bar{G} z zaporedjem stiskanj povezav, t. j. $G = (\bar{G} - R)/C$ za ustrezno izbrane množice povezav $R, C \subseteq E(\bar{G})$. Povezave R imenujemo *odstranjene povezave*, povezave v C pa *stisnjene povezave*. Ker zank ne stiskamo, je množica C aciklična. Opazimo, da množica $E(G) = E(\bar{G}) \setminus (R \cup C)$ vsebuje *originalne povezave* grafa G . Očitno je, da za vsak graf G obstaja realizirajoči graf \bar{G} , za katerega velja $R = \emptyset$.

Za vsako vozlišče $v \in V(G)$ v grafu \bar{G} obstaja enolično maksimalno drevo $T_v \leq \bar{G}[C]$, ki ga stisnemo v v . Na slikah tega razdelka bomo stisnjene povezave risali krepko, originalne pa tanko.

Minorsko prekrizno število je naravna posplošitev navadnega prekriznega števila, pri kateri dovolimo tudi križišča povezav z vozlišči (križišča originalnih in stisnjenih povezav v realizirajoči risbi) ter križišča dveh vozlišč (dveh stisnjenih povezav), prim. sliko 7.

Za kubične grafe velja $\text{mcr}(G, \Sigma) = \text{cr}(G, \Sigma)$, kar neposredno poveže teorijo minorskega prekriznega števila z navadnim. Taka povezava obstaja tudi za grafe z vozlišči višjih stopenj, saj za vsak graf obstaja kubični realizirajoči graf: vozlišča realizirajočega grafa lahko v majhni okolici brez uvedbe novih križišč zamenjamo z drevesom (če so stopnje več od tri) ali z ravninskim kubičnim grafom (če so stopnje manj od tri) in tako dobimo kubični realizirajoči graf.

Meje

Naj bo $G = H/e$ za $e = v_1v_2 \in E(H)$. Za $i = 1, 2$ naj bo $d_i = \deg_H(v_i) - 1$ število povezav, sosednjih z v_i in različnih od e , pri čemer predpostavimo $d_1 \leq d_2$. Kot je prikazano na sliki 8, lahko vsako risbo H pretvorimo v risbo G , tako da vsako križišče na povezavi e nadomestimo z največ d_1 novih križišč.

Bolj v splošnem naj bo G minor H , $G = (H - R)/C$. Potem velja $E(G) = E(H) \setminus (R \cup C)$. Risba D_H grafa H v Σ določa inducirano risbo $H - R$ v Σ brez novih križišč. S stiskanjem povezav v C pa lahko pridobimo nova križišča. Če stiskanja izvajamo zaporedoma, lahko število novih križišč nadzorujemo s pomočjo opazovanja števila originalnih povezav, ki so pripete na drevesa v $H[C]$. Na ta način pokažemo naslednji izrek:

Izrek 28. Naj bo G minor grafa H , Σ ploskev in $\tau := \lfloor \frac{1}{2}\Delta(G) \rfloor$. Potem velja

$$\text{cr}(G, \Sigma) \leq \tau^2 \text{cr}(H, \Sigma).$$

Izrek splošni rezultat Morene in Salazarja, ki sta navedeno trditev pokazala za $\Delta(G) = 4$ [86]. Iz njega neposredno sledijo naslednje meje za prekrizno število: $\text{mcr}(G, \Sigma) \leq \text{cr}(G, \Sigma) \leq \tau^2 \text{mcr}(G, \Sigma)$ in $\frac{1}{\tau^2} \text{Mcr}(G, \Sigma) \leq \text{cr}(G, \Sigma) \leq \text{Mcr}(G, \Sigma)$.

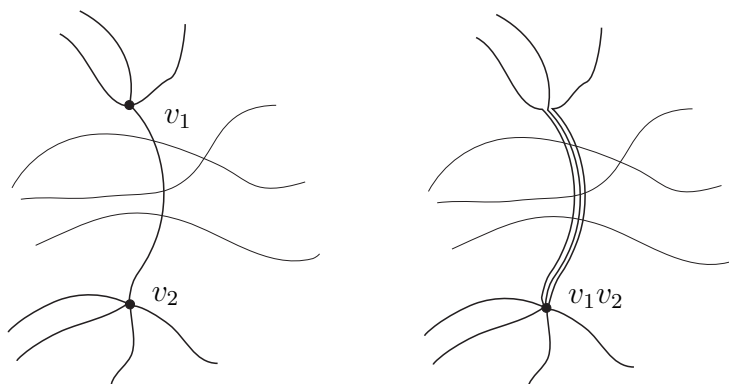

Slika 8: Stiskanje povezav na risbi.

Z nadomeščanjem križišč s projektivnimi ravninami in ročaji lahko minorsko prekrizno število omejimo z (neorientabilnim) rodom grafa:

Izrek 29. Naj bo G graf z rodom $g(G)$ in neorientabilnim rodom $\tilde{g}(G)$. Za orientabilno ploskev Σ roda $g(\Sigma)$ velja $\text{mcr}(G, \Sigma) \geq g(G) - g(\Sigma)$ in $\text{mcr}(G, \Sigma) \geq \tilde{g}(G) - 2g(\Sigma)$.

Za neorientabilno ploskev Σ roda $g(\Sigma)$ velja $\text{mcr}(G, \Sigma) \geq \tilde{g}(G) - g(\Sigma)$.

Kadar rod grafa ni znan, si lahko pomagamo z naslednjo spodnjo mejo, ki sledi iz Eulerjeve formule. Tudi v dokazu te meje uporabimo lepljenje projektivnih ravnin in ročajev namesto križišč:

Trditev 30. Za graf G z $n = |V(G)|$, $m = |E(G)|$ in notranjim obsegom r ter ploskev Σ Eulerjevega roda g velja $\text{mcr}(G, \Sigma) \geq \frac{r-2}{r}m - n - g + 2$.

To spodnjo mejo lahko izboljšamo z uporabo strukture grafov z omejenim prekriznim številom, prim. izrek 36. Tehniko menjave križišč za projektivne ravnine in ročaje lahko uporabimo tudi za primerjavo prekriznih števil v različnih ploskvah:

Trditev 31. Neenakost $\text{mcr}(G, \Sigma) \leq \max(0, \text{mcr}(G) - g(\Sigma))$ velja za vsako ploskev Σ in vsak graf G , kjer $g(\Sigma)$ predstavlja (ne)orientabilni rod ploskve Σ .

Naj bo Σ ploskev in k pozitivno celo število. Družina ploskev $\Sigma_1, \dots, \Sigma_k$ je dekompozicija ploskve Σ , $\Sigma = \Sigma_1 \# \dots \# \Sigma_k$, če je Σ homeomorfna povezani vsoti $\Sigma_1, \dots, \Sigma_k$.

Izrek 32. Naj bo Σ ploskev in G graf z bloki G_1, \dots, G_k . Potem velja

$$\sum_{i=1}^k \text{mcr}(G_i, \Sigma) \leq \text{mcr}(G, \Sigma) \leq \min \left\{ \sum_{i=1}^k \text{mcr}(G_i, \Sigma_i) \mid \Sigma = \Sigma_1 \# \dots \# \Sigma_k \right\} .$$

Povezave iz drevesa T_v , $v \in V(G)$, se v realizirajoči risbi ne sekajo, zato je število križišč med povezavami iz istega bloka strogo manjše od števila vseh križišč in spodnja meja sledi. Pri zgornji meji uporabimo drevo blokov grafa, da induktivno sestavimo risbo grafa G v Σ kot povezano vsoto risb grafov G_i v ploskvah Σ_i . Ker ima sfera \mathbb{S}_0 le trivialne dekompozicije, za vsak graf velja enakost $\text{mcr}(G) = \sum_{i=1}^k \text{mcr}(G_i)$.

Struktura grafov z omejenim mcr

Naj družina $F(k, \Sigma)$ predstavlja množico minimalnih prepovedanih minorjev za $\omega(k, \Sigma)$, $F(k)$ in $\omega(k)$ pa naj označujeta $F(k, \mathbb{S}_0)$ in $\omega(k, \mathbb{S}_0)$.

Grafi v $\omega(0, \Sigma)$ imajo preprost topološki opis — to so natanko grafi, ki jih je mogoče vložiti v ploskev Σ . Robertson in Seymour sta opazila, da je na podoben način mogoče opisati grafe iz $\omega(1)$: to so natanko grafi, ki jih je mogoče vložiti v projekтивно ravnino z lično širino dve [109]. S pomočjo tega opisa sta določila družino prepovedanih minorjev $F(1)$ za $\omega(1)$. Ta vsebuje natanko 41 grafov: G_1, \dots, G_{35} so prepovedani minorji za vložitev v projekтивно ravnino, Q_1, \dots, Q_6 pa so projekтивni grafi, ki jih dobimo iz Petersenovega grafa z $Y\Delta$, ΔY transformacijami. V nadaljevanju bomo pokazali, da ima vsaka družina $\omega(k, \Sigma)$ podoben topološki opis.

Naj bo γ enostranska enostavna sklenjena krivulja v neorientabilni ploskvi Σ Eulerjevega roda g . Z rezom Σ vzdolž γ in lepljenjem diska na dobljeno mejo dobimo ploskev Σ/γ , katere Eulerjev rod je $g - 1$. Pravimo, da smo Σ/γ dobili iz Σ z *izničanjem* projekтивne ravnine pri γ .

Množico paroma neprekrizanih enostranskih enostavnih sklenjenih krivulj $\Gamma = \{\gamma_1, \dots, \gamma_k\}$ v neorientabilni ploskvi Σ imenujemo *k-sistem* v Σ . Za različni $\gamma_i, \gamma_j \in \Gamma$ sta ploskvi $(\Sigma/\gamma_i)/\gamma_j$ in $(\Sigma/\gamma_j)/\gamma_i$ homeomorfni, torej zaporedje, v katerem izničimo krivuljam pripadajoče projekтивne ravnine, ni pomembno. Tako lahko definiramo $\Sigma/\Gamma := \Sigma/\gamma_1/\dots/\gamma_k$. Pravimo, da je *k-sistem* Γ v Σ *orientirajoči k-sistem*, če je ploskev Σ/Γ orientabilna.

Naj bo D risba grafa G v neorientabilni ploskvi Σ z največ c križišči. Če obstaja (orientirajoči) *k-sistem* Γ v Σ , tako da vsaka krivulja $\gamma \in \Gamma$ seka D v največ dveh vozliščih, je risba D (*orientirajoče*) (*c, k*)-*izrojena*, množico Γ pa imenujemo (*orientirajoči*) *k-sistem* za D . Če je $c = 0$, potem je D *k-izrojena* vložitev. Vložitev v projekтивно ravnino je 1-izrojena natanko tedaj, kadar ima lično širino največ dve. Z zamenjavo križišč za projekтивne ravnine za prvo oz. z izničevanjem projekтивnih ravnin za drugo smer pokažemo naslednjo lemo:

Lema 33. Naj bo Σ (orientabilna) ploskev Eulerjevega roda g in naj bo $k \geq 1$ celo število. Potem za vsak $l \in \{1, \dots, k\}$ družina $\omega(k, \Sigma)$ vsebuje natanko tiste grafe iz $G \in \omega(k - l, \mathbb{N}_{g+l})$, za katere obstaja graf \tilde{G} , ki vsebuje G kot minor

in ga je mogoče narisati v neorientabilni ploskvi \mathbb{N}_{g+l} Eulerjevega roda $g + l$ z (orientirajočo) izrojenostjo $(k - l, l)$.

Za naslednjo trditev opazimo, da se krivulje v k -sistemu Γ lahko dotikajo. Če več krivulj iz Γ seka isto povezavo vložitev, jih pri stiskanju povezave lahko premaknemo, da se dotikajo v stisnjemem vozlišču.

Lema 34. Naj bo \tilde{G} graf z (orientirajočo) k -izrojeno vloživijo v ploskvi Σ . Če je G ploskovni minor \tilde{G} , potem je inducirana vložitev G tudi (orientirajoče) k -izrojena.

Iz lem 33 in 34 sledi naslednji izrek:

Izrek 35. Naj bo Σ (orientabilna) ploskev Eulerjevega roda g in naj bo $k \geq 1$ celo število. Potem družina $\omega(k, \Sigma)$ vsebuje natanko vse grafe, ki jih je mogoče vložiti v neorientabilno ploskev \mathbb{N}_{g+k} Eulerjevega roda $g + k$ z (orientirajočo) izrojenostjo k .

S pomočjo izreka 35 lahko pokažemo, da za vsak graf $G \in \omega(k, \Sigma)$ obstaja graf $H \in \omega(0, \Sigma)$, tako da je G mogoče dobiti iz k z identifikacijo največ k parov vozlišč. Izrek lahko uporabimo tudi za izboljšavo spodnje meje za minorsko prekrizno število, ki izhaja iz Eulerjeve formule (trditev 30).

Izrek 36. Naj bo G enostaven graf z $n = |V_G|$, $m = |E_G|$ in Σ ploskev Eulerjevega roda g . Potem velja

$$\text{mcr}(G, \Sigma) \geq \frac{1}{2}(m - 3(n + g) + 6).$$

Za dokaz izreka potrebujemo dve tehnični lemi. S prvo pokažemo, da lahko k -sistem Γ , katerega krivulje se vse paroma dotikajo v dveh točkah, v ploskvi Σ določa največ $k - 1$ diskov, ki imajo za meje le dva loka krivulj iz Γ . k -izrojeno vložitev grafa G v neko ploskev nato dopolnimo z $2k$ povezavami, ki jih določajo krivulje k -sistema. Z odstranitvijo največ k od teh povezav se znebimo vseh lic dolžine dve. Na preostanku razširjenega grafa uporabimo Eulerjevo formulo in izrek 36 sledi.

Uporaba

Prej navedene meje v tem razdelku uporabimo na več družinah grafov. Za polne grafe pokažemo:

Trditev 37. $\lceil \frac{1}{4}(n - 3)(n - 4) \rceil \leq \text{mcr}(K_n) \leq \lfloor \frac{1}{2}(n - 5)^2 \rfloor + 4$ za $n \geq 9$.

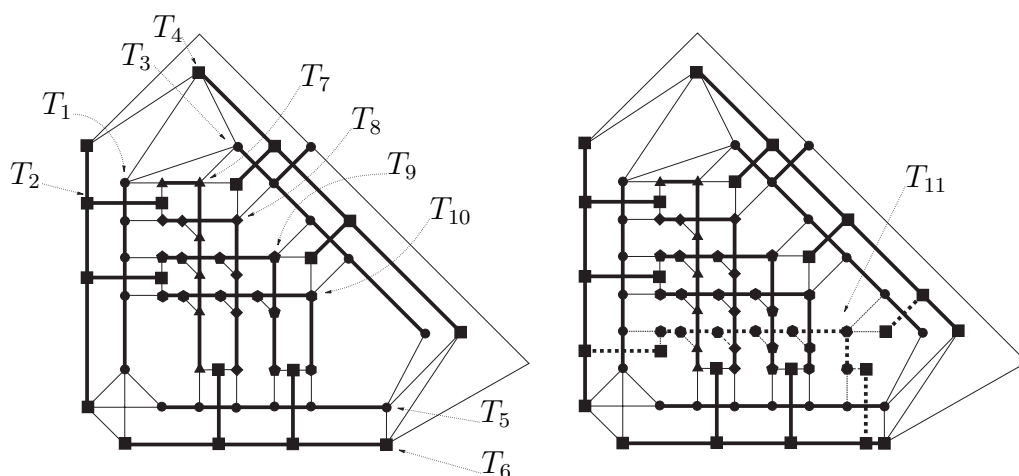
Slika 9: Risbi grafov z minorjema K_{10} in K_{11} .

Trditev sledi iz izreka 29 ter konstrukcije, prikazane na sliki 9. Za $3 \leq n \leq 8$ je spodnja meja natančna, tako velja $\text{mcr}(K_n) = 0$ za $n \leq 4$ ter $\text{mcr}(K_5) = 1$, $\text{mcr}(K_6) = 2$, $\text{mcr}(K_7) = 3$ in $\text{mcr}(K_8) = 5$.

Naslednjo trditev pokažemo z opazovanjem risb K_{n-1} v optimalni risbi K_n .

Posledica 38. Naj bo Σ neka ploskev in $c_n = \frac{\text{mcr}(K_n, \Sigma)}{n(n-1)}$ za $n \geq 3$. Zaporedje $\{c_n\}_{n=3}^{\infty}$ je nepadajoče in limita $c_{\infty} := \lim_{n \rightarrow \infty} c_n$ obstaja. Za \mathbb{S}_0 je $c_{\infty} \in [\frac{1}{4}, \frac{1}{2}]$.

Za polne dvodelne grafe pokažemo naslednje meje:

Trditev 39. $\lceil \frac{1}{2}(m-2)(n-2) \rceil \leq \text{mcr}(K_{m,n}) \leq (m-3)(n-3) + 5$ za $4 \leq m \leq n$.

Spodnja meja sledi iz izreka 29. Za $m = 3, 4$ je spodnja meja natančna:

$$\text{mcr}(K_{3,n}) = \left\lceil \frac{n-2}{2} \right\rceil \text{ in } \text{mcr}(K_{4,n}) = n-2.$$

Z uporabo izreka 28 in z najboljšimi znanimi spodnjimi mejami za prekrizno število hiperkock pokažemo naslednje meje:

Trditev 40. Za $n \geq 4$ velja $\max((n-4)2^{n-2} + 2, \frac{1}{n^2}(\frac{1}{5}4^n - 2^{n+1}) - 2^{n+1}) \leq \text{mcr}(Q_n) \leq 4^{n-2} - (n-1)2^{n-1}$.

Prva spodnja meja sledi iz trditve 30, druga pa iz rezultatov Sýkore in Vrča [121] ter izreka 28. Ta izrek dá tudi najboljšo spodnjo mejo za prekrizno število produkta dveh ciklov:

Trditev 41. $\frac{1}{4}(m-2)n \leq \text{mcr}(C_m \square C_n) \leq 2 \lfloor \frac{m-1}{2} \rfloor \lfloor \frac{n+1}{2} \rfloor$ za $3 \leq m \leq 7$, $n \geq m$, in za $m \geq 7$, $n \geq \frac{1}{2}(m+1)(m+2)$.

Izjavljam, da je disertacija plod lastnega raziskovalnega dela.

Drago Bokal